

Industry Partner

in time.
in scope.
in stock.

 SWF Switches



Inhaltsverzeichnis

(sortiert nach Nummern)



5.. 000 1/5	5.. 077 1/15	5.. 154 1/11	5.. 243 1/10	5.. 727 1/13	533 577 2/2
5.. 001 1/5	5.. 078 1/15	5.. 155 1/11	5.. 244 1/10	5.. 728 1/13	
5.. 002 1/5	5.. 079 1/15	5.. 160 1/5	5.. 245 1/10	5.. 729 1/13	587 319 4/13
5.. 003 1/5	5.. 080 1/15	5.. 161 1/5	5.. 246 1/10	5.. 730 1/13	587 321 4/8
5.. 004 1/5	5.. 081 1/15	5.. 162 1/5	5.. 247 1/15	5.. 731 1/13	587 324 4/9
5.. 005 1/5	5.. 082 1/15	5.. 163 1/5	5.. 248 1/10	5.. 732 1/14	587 460 4/9
5.. 006 1/5	5.. 083 1/15	5.. 164 1/5	5.. 249 1/6	5.. 733 1/14	587 462 4/6
5.. 007 1/5	5.. 084 1/15	5.. 165 1/5	5.. 250 1/16	5.. 734 1/14	587 464 4/9
5.. 008 1/5	5.. 085 1/10	5.. 166 1/5	5.. 255 1/12	5.. 735 1/14	587 466 4/10
5.. 009 1/5	5.. 086 1/10	5.. 167 1/5	5.. 256 1/12	5.. 736 1/14	587 467 4/3
5.. 010 1/5	5.. 087 1/10	5.. 168 1/5	5.. 257 1/12	5.. 737 1/14	587 468 4/3
5.. 011 1/5	5.. 088 1/10	5.. 169 1/5	5.. 258 1/12	5.. 738 1/14	587 471 4/15
5.. 012 1/6	5.. 089 1/10	5.. 170 1/5	5.. 259 1/12	5.. 739 1/14	587 474 4/14
5.. 013 1/6	5.. 090 1/13	5.. 171 1/5	5.. 260 1/12	5.. 740 1/14	587 476 4/6
5.. 014 1/6	5.. 091 1/13	5.. 172 1/5	5.. 261 1/12	5.. 742 1/12	587 478 4/9
5.. 015 1/6	5.. 092 1/13	5.. 173 1/5	5.. 262 1/15	5.. 743 1/12	587 480 4/8
5.. 016 1/6	5.. 093 1/13	5.. 174 1/6	5.. 263 1/15	5.. 744 1/12	587 481 4/17
5.. 017 1/6	5.. 094 1/13	5.. 175 1/6	5.. 264 1/10	5.. 745 1/12	587 483 4/9
5.. 018 1/6	5.. 095 1/9	5.. 176 1/6	5.. 265 1/10	5.. 746 1/11	587 485 4/8
5.. 019 1/6	5.. 096 1/9	5.. 177 1/6	5.. 266 1/10	5.. 747 1/11	587 487 4/8
5.. 020 1/6	5.. 097 1/9	5.. 178 1/6	5.. 267 1/10	5.. 748 1/11	587 489 4/4
5.. 021 1/6	5.. 098 1/9	5.. 179 1/6	5.. 268 1/10	5.. 749 1/11	587 490 4/14
5.. 022 1/6	5.. 099 1/9	5.. 180 1/6	5.. 269 1/10	5.. 750 1/8	587 497 4/6
5.. 023 1/6	5.. 100 1/12	5.. 181 1/7	5.. 270 1/10	5.. 751 1/8	587 499 4/12
5.. 024 1/6	5.. 101 1/12	5.. 182 1/7	5.. 271 1/8	5.. 752 1/8	587 501 4/9
5.. 025 1/6	5.. 102 1/12	5.. 183 1/7	5.. 272 1/8	5.. 753 1/8	587 504 4/18
5.. 026 1/9	5.. 103 1/12	5.. 184 1/7	5.. 273 1/8	5.. 754 1/8	587 505 4/11
5.. 027 1/9	5.. 104 1/12	5.. 185 1/7	5.. 274 1/8	5.. 755 1/8	587 643 4/10
5.. 028 1/9	5.. 105 1/6	5.. 186 1/7	5.. 275 1/8	5.. 756 1/8	587 645 4/10
5.. 029 1/9	5.. 106 1/6	5.. 187 1/7	5.. 276 1/8	5.. 758 1/11	587 660 4/3
5.. 030 1/9	5.. 107 1/6	5.. 190 1/16	5.. 277 1/8	5.. 759 1/11	587 662 4/16
5.. 031 1/9	5.. 108 1/6	5.. 191 1/16	5.. 278 1/16	5.. 762 1/14	587 664 4/9
5.. 032 1/9	5.. 109 1/6	5.. 192 1/16	5.. 279 1/8	5.. 763 1/14	587 666 4/7
5.. 033 1/8	5.. 110 1/6	5.. 193 1/16	5.. 280 1/8	5.. 764 1/14	587 668 4/9
5.. 034 1/8	5.. 111 1/6	5.. 194 1/16	5.. 281 1/8	5.. 765 1/14	587 670 4/6
5.. 035 1/8	5.. 112 1/14	5.. 195 1/16	5.. 282 1/8	5.. 766 1/14	587 672 4/9
5.. 036 1/8	5.. 113 1/14	5.. 197 1/7	5.. 283 1/8	5.. 768 1/12	587 674 4/11
5.. 037 1/8	5.. 114 1/14	5.. 198 1/7	5.. 286 1/11	5.. 769 1/12	587 676 4/17
5.. 038 1/8	5.. 115 1/14	5.. 199 1/7	5.. 287 1/11	5.. 770 1/12	587 678 4/17
5.. 039 1/8	5.. 116 1/14	5.. 200 1/7	5.. 288 1/11	5.. 771 1/12	587 680 4/16
5.. 040 1/8	5.. 117 1/15	5.. 201 1/7	5.. 289 1/11	5.. 772 1/12	587 681 4/10
5.. 041 1/8	5.. 118 1/15	5.. 202 1/9	5.. 290 1/11	501 338 1/4	587 684 4/17
5.. 042 1/8	5.. 119 1/15	5.. 203 1/9	5.. 291 1/7		587 686 4/17
5.. 043 1/8	5.. 120 1/15	5.. 204 1/9	5.. 292 1/7	511 500 1/3	587 688 4/17
5.. 044 1/8	5.. 121 1/15	5.. 205 1/9	5.. 293 1/7	511 501 1/3	587 690 4/13
5.. 045 1/13	5.. 122 1/7	5.. 206 1/9	5.. 294 1/7	511 502 1/3	587 692 4/10
5.. 046 1/13	5.. 123 1/7	5.. 207 1/9	5.. 295 1/7	511 503 1/3	587 694 4/17
5.. 047 1/13	5.. 124 1/7	5.. 208 1/9	5.. 296 1/11		587 740 4/14
5.. 048 1/13	5.. 125 1/7	5.. 209 1/15	5.. 297 1/11	533 500 1/3	587 742 4/17
5.. 049 1/13	5.. 126 1/7	5.. 210 1/15	5.. 299 1/8	533 501 1/3	587 744 4/13
5.. 050 1/11	5.. 127 1/6	5.. 211 1/12	5.. 700 1/13	533 502 1/3	587 746 4/8
5.. 051 1/11	5.. 128 1/6	5.. 212 1/12	5.. 701 1/13	533 503 1/3	587 748 4/15
5.. 052 1/11	5.. 129 1/6	5.. 213 1/12	5.. 702 1/13	533 505 2/1	587 750 4/4
5.. 053 1/11	5.. 130 1/6	5.. 214 1/12	5.. 703 1/13	533 551 2/2	587 751 4/2
5.. 054 1/11	5.. 131 1/6	5.. 215 1/12	5.. 704 1/13	533 552 2/2	587 754 4/10
5.. 055 1/12	5.. 132 1/7	5.. 216 1/12	5.. 705 1/13	533 553 2/2	587 757 4/10
5.. 056 1/12	5.. 133 1/7	5.. 217 1/12	5.. 706 1/13	533 554 2/2	587 760 4/10
5.. 057 1/12	5.. 134 1/7	5.. 218 1/15	5.. 707 1/9	533 555 2/2	587 795 4/13
5.. 058 1/12	5.. 135 1/7	5.. 219 1/15	5.. 708 1/10	533 556 2/1	587 890 4/15
5.. 059 1/12	5.. 136 1/7	5.. 220 1/15	5.. 709 1/13	533 557 2/1	587 896 3/36
5.. 060 1/12	5.. 137 1/10	5.. 226 1/9	5.. 710 1/13	533 558 2/1	587 898 4/15
5.. 061 1/12	5.. 138 1/10	5.. 227 1/9	5.. 711 1/9	533 560 2/2	587 917 4/16
5.. 062 1/12	5.. 139 1/10	5.. 228 1/9	5.. 712 1/9	533 561 2/1	587 964 4/8
5.. 063 1/12	5.. 140 1/10	5.. 229 1/9	5.. 713 1/14	533 562 2/1	587 965 4/17
5.. 064 1/12	5.. 141 1/10	5.. 230 1/9	5.. 714 1/14	533 564 2/1	587 967 4/14
5.. 065 1/11	5.. 142 1/10	5.. 231 1/9	5.. 715 1/13	533 565 2/1	587 969 4/6
5.. 066 1/11	5.. 143 1/10	5.. 232 1/9	5.. 716 1/13	533 566 2/1	587 977 4/6
5.. 067 1/11	5.. 144 1/10	5.. 233 1/7	5.. 717 1/13	533 567 2/1	587 979 4/17
5.. 068 1/11	5.. 145 1/10	5.. 234 1/7	5.. 718 1/13	533 568 2/1	587 980 4/14
5.. 069 1/11	5.. 146 1/11	5.. 235 1/7	5.. 719 1/13	533 569 2/1	587 982 4/6
5.. 070 1/12	5.. 147 1/11	5.. 236 1/7	5.. 720 1/13	533 570 2/1	587 984 4/13
5.. 071 1/12	5.. 148 1/11	5.. 237 1/7	5.. 721 1/13	533 571 2/1	587 985 4/16
5.. 072 1/12	5.. 149 1/11	5.. 238 1/7	5.. 722 1/13	533 572 2/1	587 987 4/7
5.. 073 1/12	5.. 150 1/11	5.. 239 1/7	5.. 723 1/13	533 573 2/2	587 989 3/29
5.. 074 1/12	5.. 151 1/11	5.. 240 1/10	5.. 724 1/13	533 574 2/2	587 317 3/48
5.. 075 1/15	5.. 152 1/11	5.. 241 1/10	5.. 725 1/13	533 575 2/1	587 455 3/22
5.. 076 1/15	5.. 153 1/11	5.. 242 1/10	5.. 726 1/13	533 576 2/1	587 512 3/22



587 514 3/22	588 222 4/14	588 582 4/13	589 199 3/28	589 909 3/49	590 824 3/55
587 516 3/22	588 224 4/18	588 583 4/3	589 206 3/53	589 914 3/26	590 827 3/52
587 518 3/22	588 226 4/16	588 584 4/3	589 286 3/46	589 916 3/27	590 828 3/10
587 520 3/22	588 228 4/8	588 585 4/3	589 308 3/50	589 923 3/41	590 868 3/29
587 522 3/22	588 230 4/16	588 586 4/4	589 309 3/50	589 925 3/39	590 946 3/44
587 524 3/23	588 231 4/5	588 587 4/5	589 310 3/52	589 926 3/2	590 948 3/24
587 762 3/29	588 233 4/3	588 621 4/3	589 313 3/41	589 929 3/34	590 988 3/29
587 763 3/23	588 234 4/3	588 622 4/3	589 315 3/48	589 930 3/2	590 989 3/30
587 764 3/36	588 249 3/23	588 623 4/14	589 320 3/47	589 931 3/27	590 990 3/55
587 793 3/31	588 255 3/40	588 624 4/15	589 348 3/26	589 932 3/32	
587 836 3/32	588 257 3/35	588 625 4/6	589 482 3/28	589 936 3/51	591 018 3/42
587 838 3/37	588 286 4/1	588 626 4/2	589 486 3/10	589 938 3/2	591 020 3/43
	588 297 4/15	588 627 4/2	589 488 3/29	589 939 3/2	591 022 3/40
	588 298 4/13	588 628 4/4	589 490 3/12	589 940 3/29	591 024 3/55
588 008 4/15	588 299 4/17	588 682 4/16	589 492 3/12	589 950 3/24	591 026 3/42
588 010 4/18	588 302 4/13	588 687 4/13	589 494 3/38		591 028 3/24
588 012 4/13	588 303 4/2	588 688 4/4	589 496 3/27	590 002 3/43	591 031 3/29
588 014 4/13	588 304 4/15	588 708 4/6	589 500 3/27	590 048 3/22	591 032 3/48
588 016 4/17	588 305 4/13	588 709 4/13	589 502 3/12	590 050 3/40	591 034 3/36
588 034 4/16	588 306 4/15	588 710 4/2	589 504 3/48	590 052 3/24	591 036 3/2
588 036 4/15	588 307 4/8	588 711 4/3	589 506 3/53	590 066 3/29	591 038 3/36
588 038 4/14	588 310 4/4	588 712 4/4	589 508 3/36	590 068 3/11	591 040 3/40
588 040 4/8	588 311 4/14	588 713 4/16	589 511 3/27	590 072 3/36	591 042 3/31
588 042 4/2	588 312 4/2	588 714 4/13	589 512 3/35	590 074 3/29	591 044 3/31
588 043 4/17	588 313 4/15	588 715 4/4	589 514 3/22	590 080 3/10	591 077 3/51
588 044 4/17	588 314 4/17	588 716 4/6	589 516 3/22	590 082 3/36	591 152 3/46
588 046 4/15	588 315 4/16	588 717 4/13	589 517 3/28	590 094 3/51	591 154 3/40
588 049 4/4	588 316 4/18	588 718 4/2	589 518 3/46	590 095 3/24	591 156 3/41
588 056 4/2	588 317 4/7	588 719 4/3	589 520 3/9	590 210 3/55	591 158 3/44
588 057 4/13	588 318 4/14	588 720 4/4	589 521 3/22	590 243 3/29	591 160 3/10
588 060 4/3	588 319 4/13	588 746 3/36	589 523 3/23	590 246 3/27	591 162 3/50
588 062 4/14	588 320 4/13	588 748 3/48	589 532 3/54	590 248 3/51	591 164 3/47
588 067 4/18	588 321 4/17	588 788 3/55	589 534 3/9	590 281 3/49	591 190 3/11
588 068 4/16	588 322 4/4	588 794 3/50	589 536 3/10	590 300 3/46	591 192 3/25
588 069 4/16	588 323 4/7	588 796 3/32	589 538 3/10	590 302 3/51	591 197 3/24
588 070 4/14	588 324 4/6	588 798 3/32	589 540 3/10	590 306 3/29	591 207 3/29
588 071 4/2	588 325 4/15	588 802 3/52	589 565 3/54	590 308 3/51	591 215 3/55
588 074 4/3	588 326 4/14	588 804 3/52	589 581 3/48	590 422 3/47	591 226 3/41
588 075 4/16	588 327 4/13	588 826 3/43	589 668 3/28	590 443 3/47	591 227 3/44
588 076 4/8	588 328 4/16	588 843 3/40	589 674 3/2	590 548 3/28	591 228 3/10
588 077 4/15	588 329 4/8	588 845 3/54	589 675 3/2	590 577 3/51	591 236 3/51
588 078 4/18	588 330 4/14	588 847 3/37	589 694 3/27	590 580 3/28	591 265 3/10
588 084 4/6	588 331 4/7	588 849 3/23	589 695 3/9	590 582 3/28	591 284 3/36
588 087 4/4	588 332 4/18	588 852 3/39	589 696 3/9	590 584 3/2	591 285 3/37
588 088 4/3	588 333 4/6	588 854 3/39	589 698 3/49	590 588 3/2	591 286 3/10
588 089 4/3	588 334 4/4	588 871 3/42	589 706 3/2	590 590 3/2	591 287 3/2
588 090 4/3	588 335 4/3	588 872 3/45	589 708 3/2	590 592 3/9	591 299 3/27
588 094 4/6	588 336 4/4	588 937 3/49	589 762 3/37	590 594 3/55	591 305 3/29
588 095 4/2	588 337 4/6	588 939 3/50	589 772 3/47	590 596 3/55	591 315 3/27
588 096 4/14	588 338 4/6	588 942 1/3	589 776 3/48	590 608 3/39	591 316 3/29
588 097 4/4	588 339 4/18	588 985 3/51	589 778 3/26	590 620 3/53	591 317 3/46
588 102 4/15	588 340 4/18	588 987 3/35	589 780 3/8	590 634 3/2	591 318 3/28
588 108 4/8	588 341 4/17	588 989 3/44	589 783 3/49	590 658 3/48	591 319 3/24
588 110 4/16	588 342 4/17	588 991 3/45	589 790 1/4	590 660 3/39	591 320 3/23
588 111 4/3	588 343 4/16	588 992 3/40	589 798 3/24	590 662 3/47	591 322 3/52
588 115 4/16	588 394 4/4	588 994 3/38	589 829 3/23	590 664 3/35	591 324 3/49
588 117 4/14	588 396 4/6	588 996 3/36	589 838 3/41	590 666 3/46	591 337 3/2
588 122 4/15	588 398 4/2	588 998 3/52	589 840 3/2	590 668 3/41	591 339 3/8
588 124 4/16	588 400 4/1		589 841 3/51	590 670 3/55	591 341 3/2
588 126 4/16	588 401 4/1	589 042 3/32	589 842 3/2	590 672 3/33	591 343 3/2
588 128 4/8	588 402 4/1	589 043 3/33	589 874 3/41	590 674 3/32	591 345 3/2
588 130 4/14	588 434 3/24	589 064 3/2	589 876 3/32	590 676 3/33	591 346 3/2
588 131 4/16	588 435 4/5	589 065 3/2	589 878 3/32	590 680 3/39	591 347 3/29
588 135 4/3	588 548 4/2	589 067 3/25	589 880 3/39	590 682 3/2	591 349 3/28
588 136 4/4	588 549 4/8	589 068 3/22	589 882 3/40	590 684 3/49	591 351 3/40
588 137 4/4	588 550 4/4	589 075 3/48	589 884 3/32	590 786 3/12	591 353 3/47
588 138 4/7	588 551 4/5	589 077 3/54	589 886 3/54	590 790 3/33	591 355 3/35
588 142 4/3	588 570 4/13	589 079 3/51	589 888 3/49	590 792 3/31	591 357 3/35
588 143 4/6	588 571 4/15	589 148 3/54	589 889 3/42	590 794 3/32	591 361 3/40
588 148 4/3	588 572 4/14	589 150 3/38	589 893 3/32	590 796 3/34	591 363 3/53
588 157 4/14	588 573 4/3	589 170 3/50	589 895 3/32	590 798 3/32	591 365 3/2
588 175 4/4	588 574 4/14	589 176 3/43	589 897 3/23	590 800 3/11	591 367 3/49
588 189 4/17	588 575 4/6	589 181 3/47	589 899 3/32	590 802 3/48	591 369 3/27
588 192 3/51	588 576 4/3	589 183 3/46	589 901 3/40	590 805 3/33	591 371 3/53
588 193 4/15	588 577 4/2	589 193 3/2	589 903 3/38	590 808 3/49	591 373 3/2
588 193 4/15	588 578 4/15	589 195 3/2	589 906 3/51	590 812 3/43	591 374 3/27
588 213 4/17	588 581 4/4	589 197 3/49	589 907 3/29	590 814 3/42	591 376 3/26
588 216 4/18					
588 218 4/16					
588 220 4/16					



591 378 3/23	591 775 3/2	592 370 3/11	592 772 3/2	593 293 3/27	593 443 3/31
591 380 3/28	591 799 3/24	592 371 3/43	592 776 3/2	593 294 3/26	593 445 3/23
591 382 3/43	591 801 3/23	592 372 3/11	592 787 3/2	593 295 3/27	593 446 3/41
591 423 3/55	591 803 3/23	592 373 3/2	592 790 3/49	593 296 3/27	593 447 3/41
591 425 3/40	591 811 3/43	592 375 3/33	592 851 3/30	593 297 3/26	593 496 3/50
591 433 3/53	591 820 3/49	592 377 3/29	592 852 3/30	593 301 3/27	593 556 3/1
591 435 3/28	591 824 3/9	592 391 3/2	592 853 3/23	593 302 3/53	593 597 3/12
591 445 3/55	591 826 3/8	592 392 3/2	592 854 3/24	593 303 3/2	593 601 3/1
591 447 3/55	591 829 3/36	592 393 3/2	592 855 3/24	593 304 3/2	593 602 3/45
591 449 3/43	591 831 3/28	592 397 3/41	592 860 3/2	593 305 3/2	593 603 3/2
591 451 3/38	591 833 3/35	592 399 3/43	592 870 3/2	593 306 3/2	593 604 3/43
591 497 3/33	591 835 3/35	592 407 3/10	592 874 3/55	593 307 3/9	593 605 3/46
591 499 3/44	591 844 3/50	592 424 3/34	592 875 3/45	593 308 3/2	593 606 3/9
591 501 3/38	591 849 3/49	592 425 3/33	592 876 3/2	593 309 3/28	593 607 3/12
591 503 3/42	591 878 3/2	592 426 3/33	592 877 3/35	593 311 3/2	593 608 3/9
591 505 3/8	591 879 3/2	592 427 3/52	592 878 3/25	593 312 3/29	593 609 3/2
591 507 3/37	591 891 3/37	592 428 3/47	592 879 3/54	593 313 3/39	593 610 3/2
591 535 3/35	591 895 3/8	592 429 3/47	592 889 3/2	593 314 3/45	593 611 3/2
591 537 3/55	591 933 3/2	592 430 3/53	592 896 3/2	593 315 3/2	593 612 3/2
591 542 3/40		592 431 3/41	592 897 3/35	593 316 3/9	593 613 3/2
591 550 3/2	592 003 3/54	592 432 3/50	592 898 3/8	593 317 3/9	593 616 3/52
591 552 3/2	592 004 3/24	592 459 3/2	592 900 3/39	593 318 3/9	593 619 3/28
591 565 3/39	592 022 3/8	592 460 3/45	592 905 3/55	593 319 3/53	593 620 3/40
591 567 3/49	592 028 3/39	592 461 3/40	592 906 3/47	593 320 3/45	593 621 3/45
591 569 3/48	592 031 3/27	592 462 3/2	592 910 3/42	593 321 3/53	593 622 3/46
591 571 3/44	592 032 3/41	592 463 3/42	592 911 3/28	593 322 3/53	593 626 3/30
591 573 3/34	592 033 3/37	592 464 3/49	592 912 3/28	593 323 3/51	593 627 3/43
591 575 3/27	592 035 3/51	592 465 3/42	592 916 3/2	593 324 3/53	593 628 3/51
591 577 3/39	592 037 3/39	592 466 3/40	592 919 3/47	593 327 3/28	593 629 3/2
591 579 3/26	592 039 3/36	592 467 3/45	592 989 3/38	593 329 3/47	593 631 3/2
591 581 3/11	592 041 3/53	592 468 3/51	592 995 3/34	593 330 3/47	593 632 3/39
591 582 3/48	592 043 3/46	592 470 3/38	592 996 3/51	593 331 3/11	593 635 3/41
591 584 3/55	592 045 3/40	592 471 3/45		593 332 3/26	593 639 3/24
591 605 3/23	592 047 3/46	592 473 3/37	593 040 3/28	593 333 3/36	593 641 3/39
591 613 3/42	592 049 3/51	592 474 3/2	593 042 3/42	593 334 3/45	593 642 3/50
591 615 3/8	592 054 3/2	592 475 3/45	593 044 3/24	593 335 3/48	593 644 3/43
591 617 3/35	592 094 3/11	592 476 3/2	593 050 3/30	593 336 3/54	593 664 3/34
591 619 3/32	592 095 3/47	592 477 3/45	593 051 3/30	593 337 3/8	593 665 3/28
591 626 3/9	592 096 3/47	592 480 3/2	593 058 3/54	593 338 3/52	593 666 3/23
591 628 3/46	592 119 3/10	592 481 3/48	593 059 3/48	593 340 3/26	593 676 3/27
591 630 3/2	592 121 3/12	592 482 3/8	593 060 3/8	593 341 3/47	593 678 3/2
591 632 3/2	592 123 3/2	592 483 3/2	593 061 3/52	593 342 3/47	593 705 1/4
591 634 3/8	592 129 3/44	592 484 3/35	593 062 3/45	593 343 3/47	593 706 1/4
591 636 3/48	592 131 3/2	592 485 3/33	593 063 3/2	593 345 3/43	593 757 1/4
591 638 3/2	592 133 3/44	592 486 3/50	593 064 3/51	593 346 3/9	
591 640 3/2	592 135 3/10	592 520 3/39	593 067 3/2	593 347 3/41	594 268 1/4
591 642 3/29	592 137 3/2	592 522 3/22	593 068 3/12	593 349 3/11	594 269 1/4
591 644 3/33	592 147 3/54	592 523 3/38	593 070 3/2	593 351 3/10	594 400 3/2
591 646 3/23	592 149 3/52	592 524 3/31	593 174 3/47	593 352 3/11	594 401 3/2
591 648 3/2	592 151 3/43	592 525 3/31	593 175 3/11	593 354 3/10	594 408 3/2
591 650 3/2	592 153 3/27	592 544 1/2	593 176 3/41	593 355 3/36	594 411 3/34
591 654 3/33	592 162 3/35	592 582 3/31	593 177 3/37	593 401 3/42	594 412 3/32
591 656 3/42	592 164 3/2	592 583 3/31	593 178 3/2	593 402 3/42	594 413 3/55
591 660 3/2	592 166 3/2	592 584 3/30	593 179 3/26	593 403 3/42	594 414 3/26
591 662 3/2	592 168 3/39	592 585 3/30	593 180 3/36	593 404 3/55	594 416 3/2
591 664 3/2	592 170 3/2	592 586 3/31	593 181 3/45	593 405 3/55	594 417 3/50
591 666 3/2	592 172 3/8	592 587 3/43	593 182 3/48	593 407 3/30	594 418 3/24
591 667 3/2	592 174 3/8	592 592 3/27	593 183 3/54	593 408 3/30	594 419 3/53
591 668 3/2	592 175 3/39	592 594 3/8	593 184 3/8	593 410 3/30	594 420 3/10
591 669 3/2	592 178 3/2	592 637 3/41	593 185 3/52	593 411 3/30	594 421 3/52
591 677 3/28	592 180 3/39	592 638 3/2	593 187 3/26	593 413 3/23	594 422 3/36
591 680 3/26	592 185 3/25	592 684 3/9	593 188 3/47	593 414 3/22	594 423 3/10
591 682 3/24	592 187 3/2	592 685 3/2	593 189 3/2	593 416 3/30	594 425 3/39
591 683 3/23	592 189 3/33	592 686 3/2	593 194 3/26	593 417 3/30	594 427 3/46
591 688 3/2	592 304 3/45	592 688 3/44	593 240 1/3	593 419 3/52	594 428 3/2
591 689 3/2	592 305 3/2	592 691 3/39	593 270 3/1	593 420 3/52	594 429 3/50
591 690 3/2	592 306 3/54	592 692 3/2	593 271 3/1	593 422 3/38	594 430 3/45
591 693 3/37	592 348 3/2	592 693 3/2	593 278 3/52	593 424 3/40	594 433 3/2
591 708 3/26	592 352 3/2	592 694 3/2	593 279 3/8	593 425 3/36	594 434 3/53
591 713 3/24	592 353 3/41	592 695 3/2	593 281 3/48	593 435 3/39	594 436 3/35
591 715 3/32	592 354 3/35	592 697 3/24	593 282 3/38	593 436 3/38	594 437 3/51
591 731 3/28	592 355 3/2	592 702 3/32	593 283 3/28	593 437 3/31	594 438 3/11
591 732 3/28	592 360 3/42	592 703 3/33	593 284 3/41	593 438 3/30	594 439 3/54
591 755 3/39	592 364 3/46	592 704 3/2	593 289 3/10	593 439 3/31	594 440 3/26
591 759 3/11	592 365 3/37	592 765 3/44	593 290 3/46	593 440 3/30	594 441 3/54
591 765 3/11	592 367 3/39	592 770 3/12	593 291 3/50	593 441 3/31	594 442 3/50
591 773 3/2	592 368 3/43	592 771 3/2	593 292 3/55	593 442 3/30	594 444 3/54



594 445 3/54	594 719 3/2	595 111 3/26	595 404 3/50	596 126 3/54	596 312 3/2
594 446 3/31	594 720 3/2	595 112 3/2	595 405 3/31	596 127 3/41	596 313 3/2
594 447 3/37	594 721 3/2	595 113 3/2	595 406 3/32	596 128 3/37	596 336 3/2
594 448 3/44	594 722 3/2	595 114 3/31	595 407 3/33	596 134 3/2	596 338 3/27
594 449 3/37	594 723 3/2	595 115 3/47	595 408 3/31	596 135 3/29	596 340 3/53
594 450 3/37	594 724 3/47	595 116 3/2	595 409 3/32	596 136 3/2	596 381 3/49
594 451 3/9	594 725 3/47	595 117 3/2	595 410 3/23	596 137 3/2	596 388 3/9
594 452 3/38	594 727 3/43	595 118 3/2	595 417 3/2	596 138 3/41	596 390 3/9
594 453 3/54	594 728 3/9	595 119 3/37	595 418 3/2	596 139 3/11	596 391 3/26
594 454 3/30	594 729 3/22	595 120 3/37	595 419 3/26	596 140 3/10	596 393 3/44
594 455 3/9	594 730 3/46	595 121 3/48	595 420 3/55	596 141 3/36	596 394 3/2
594 456 3/50	594 731 3/28	595 122 3/52	595 421 3/47	596 142 3/37	596 395 3/11
594 457 3/35	594 733 3/37	595 123 3/41	595 424 3/46	596 144 3/27	596 397 3/45
594 458 3/8	594 734 3/37	595 124 3/52	595 425 3/36	596 145 3/2	596 398 3/45
594 459 3/45	594 737 3/38	595 125 3/45	595 426 3/2	596 146 3/2	596 400 3/2
594 460 3/43	594 738 3/2	595 126 3/35	595 428 3/33	596 147 3/43	596 401 3/2
594 461 3/43	594 739 3/2	595 127 3/9	595 429 3/23	596 149 3/46	596 402 3/12
594 462 3/9	594 741 3/53	595 128 3/42	595 431 3/44	596 150 3/53	596 403 3/42
594 463 3/39	594 742 3/12	595 129 3/45	595 432 3/35	596 151 3/2	596 404 3/2
594 464 3/8	594 743 3/43	595 130 3/44	595 433 3/2	596 152 3/54	596 406 3/2
594 465 3/8	594 744 3/41	595 131 3/46	595 434 3/24	596 153 3/41	596 407 3/9
594 466 3/11	594 746 3/2	595 132 3/9	595 436 3/24	596 154 3/55	596 408 3/2
594 467 3/44	594 749 3/2	595 133 3/11	595 437 3/11	596 155 3/31	596 409 3/2
594 468 3/44	594 751 3/2	595 134 3/45	595 438 3/33	596 156 3/30	596 410 3/11
594 469 3/42	594 752 3/27	595 135 3/11	595 439 3/2	596 157 3/30	596 411 3/9
594 470 3/10	594 754 3/26	595 136 3/41	595 440 3/9	596 160 3/45	596 414 3/2
594 471 3/23	594 755 3/30	595 137 3/9	595 441 3/38	596 161 3/43	596 415 3/2
594 474 3/2	594 756 3/24	595 138 3/10	595 442 3/38	596 162 3/23	596 416 3/2
594 475 3/2	594 757 3/33	595 139 3/10	595 443 3/39	596 169 3/2	596 417 3/2
594 476 3/36	594 758 3/33	595 140 3/12	595 444 3/26	596 170 3/2	596 418 3/2
594 478 3/46	594 759 3/33	595 141 3/9	595 495 3/52	596 171 3/37	596 422 3/8
594 479 3/12	594 760 3/39	595 142 3/9	595 496 3/45	596 172 3/9	596 424 3/2
594 480 3/2	594 761 3/26	595 143 3/2	595 497 3/49	596 173 3/27	596 426 3/2
594 481 3/22	594 763 3/2	595 144 3/52	595 498 3/49	596 174 3/37	596 469 3/47
594 482 3/22	594 764 3/35	595 145 3/46	595 499 3/49	596 175 3/2	596 472 3/2
594 484 3/2	594 765 3/29	595 146 3/11	595 501 3/29	596 176 3/46	596 473 3/2
594 485 3/2	594 766 3/24	595 148 3/27	595 502 1/3	596 177 3/27	596 600 3/2
594 486 3/9	594 767 3/2	595 149 3/9	595 549 3/45	596 178 3/54	596 601 3/2
594 487 3/41	594 768 3/2	595 150 3/55	595 620 3/1	596 179 3/45	596 602 3/26
594 488 3/47	594 769 3/2	595 151 3/42	595 847 3/2	596 180 3/9	596 603 3/2
594 489 3/33	594 770 3/2	595 152 3/24	595 851 3/54	596 182 3/22	596 604 3/9
594 490 3/51	594 771 3/44	595 153 3/44	595 852 3/54	596 184 3/2	596 609 3/2
594 492 3/48	594 772 3/44	595 154 3/42	595 853 3/24	596 185 3/29	596 610 3/1
594 493 3/2	594 773 3/22	595 157 3/36	595 902 1/3	596 186 3/50	596 611 3/2
594 494 3/38	594 774 3/22	595 158 3/36	595 965 3/2	596 187 3/52	596 612 3/9
594 495 3/28	594 775 3/36	595 159 3/10	595 967 3/54	596 188 3/51	596 613 3/48
594 496 3/9	594 779 3/2	595 160 3/48	595 969 3/29	596 189 3/2	596 614 3/2
594 497 3/43	594 780 3/45	595 162 3/50	595 971 3/29	596 190 3/9	596 615 3/1
594 498 3/43	594 781 3/2	595 163 3/24		596 191 3/2	596 619 3/2
594 499 3/26	594 782 3/2	595 164 3/27	596 064 3/44	596 192 3/2	596 620 3/1
594 500 3/40	594 787 3/2	595 165 3/44	596 090 3/46	596 194 3/54	596 621 3/2
594 585 1/3	594 788 3/2	595 166 3/44	596 091 3/55	596 195 3/8	596 622 3/9
594 645 3/1	594 789 3/43	595 167 3/44	596 092 3/31	596 196 3/46	596 625 3/2
594 646 3/1	594 790 3/38	595 176 3/51	596 093 3/45	596 197 3/53	596 626 3/2
594 647 3/36	594 791 3/38	595 180 3/2	596 101 3/10	596 198 3/22	596 627 3/2
594 648 3/27	594 792 3/43	595 181 3/2	596 102 3/35	596 202 3/32	596 628 3/2
594 649 3/38	594 793 3/51	595 182 3/2	596 103 3/41	596 203 3/51	596 629 3/2
594 650 3/38	594 795 3/9	595 183 3/26	596 104 3/31	596 204 3/48	596 630 3/8
594 665 3/2	594 796 3/12	595 184 3/47	596 105 3/46	596 205 3/44	596 631 3/12
594 700 3/11	594 797 3/42	595 186 3/29	596 106 3/53	596 221 3/50	596 632 3/9
594 701 3/2	594 798 3/2	595 188 3/2	596 107 3/28	596 222 3/37	596 633 3/8
594 702 3/11	594 799 3/2	595 189 3/25	596 108 3/41	596 226 3/43	596 634 3/46
594 703 3/2	594 800 3/2	595 190 3/28	596 109 3/2	596 230 3/1	596 635 3/46
594 704 3/38	594 801 1/3	595 191 3/2	596 110 3/2	596 238 3/44	596 636 3/2
594 705 3/2	594 802 1/3	595 192 3/10	596 112 3/37	596 239 1/2	596 637 3/2
594 706 3/2		595 193 3/27	596 113 3/36	596 252 1/2	596 638 3/2
594 707 3/26	595 100 3/2	595 194 3/27	596 114 3/36	596 253 1/2	596 639 3/2
594 708 3/2	595 101 3/11	595 195 3/2	596 115 3/35	596 273 1/2	596 640 3/2
594 709 3/28	595 102 3/2	595 196 3/37	596 117 3/12	596 289 1/4	596 641 3/2
594 710 3/30	595 103 3/23	595 197 3/36	596 118 3/23	596 296 3/37	596 642 3/9
594 711 3/32	595 104 3/36	595 198 3/41	596 119 3/32	596 298 3/37	596 643 3/42
594 713 3/52	595 105 3/2	595 199 3/37	596 120 3/12	596 301 3/43	596 645 3/9
594 714 3/2	595 106 3/2	595 200 3/43	596 121 3/12	596 303 3/2	596 646 3/9
594 715 3/2	595 107 3/2	595 200 3/46	596 122 3/43	596 305 3/2	596 647 3/2
594 716 3/35	595 108 3/9	595 401 3/2	596 123 3/2	596 307 3/2	596 648 3/2
594 717 3/2	595 109 3/2	595 402 3/2	596 124 3/45	596 309 3/27	596 649 3/2
594 718 3/2	595 110 3/37	595 403 3/50	596 125 3/47	596 311 3/49	596 650 3/1



596 651 3/2
596 652 3/37
596 653 3/53
596 654 3/2
596 655 3/2
596 710 1/2
596 799 3/2
596 801 3/2
596 956 1/2

904 404 1/2

913 328 1/4

920 678 1/2

Tastenkippschalter
 Rocker switches
 Interrupteurs à bascule
 Interruttore basculante
 Interruptores basculantes

Für / for / pour / per / para
 511... 523...
 512... 524...
 521... 533...

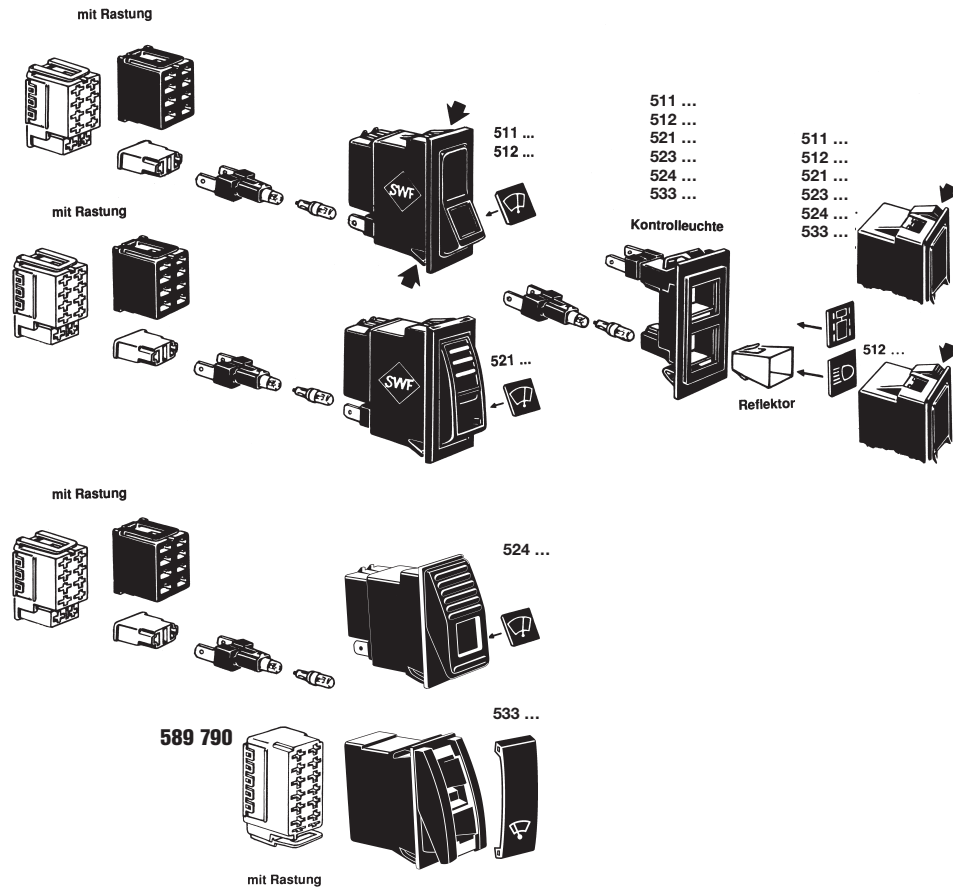

511...
 512...
 521...
 524... 533...

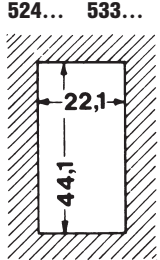

2 x 594 802

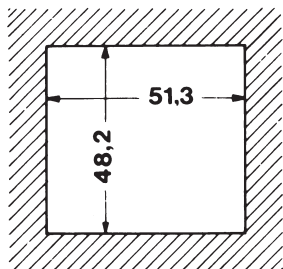

Einbauöffnung

2 x 594 802 + ..594 801

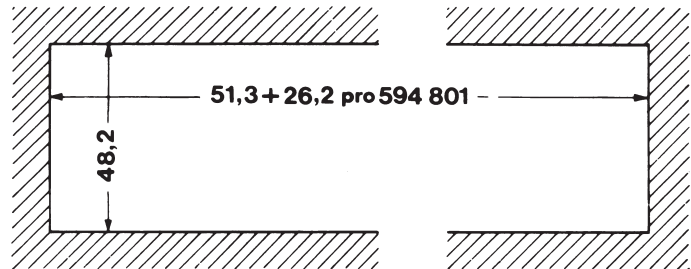

595 502

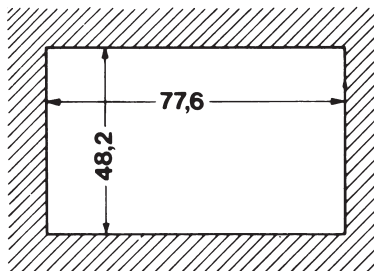





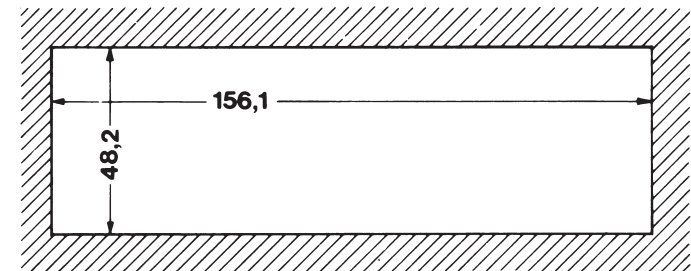



Einbauöffnung

595 902



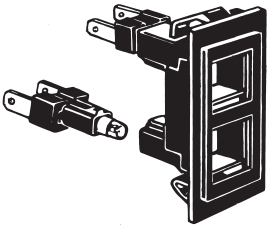
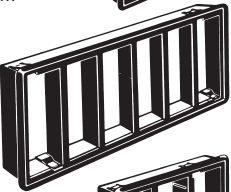

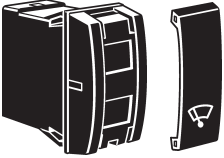
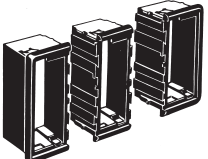

Valeo
 Laiernstr. 12
 D - 74321 Bietigheim-Bissingen

Tel.: 49 (0)7142 916-0
 Fax: 49 (0)7142 916-4726

Benennung Description Dénomination Denominazione Denominación	Volt Volts Volts Volt Voltios	No	Benennung Description Dénomination Denominazione Denominación	Farbe Colour Couleur Colore Color	No
Fassung mit Glassockellampe Socket with wedge base lamp Douille avec lampes à socle en verre Supporto con lampadina con zoccolo di vetro Portalámpara con lámpara con zócolo de vidrio 	12 28	596 956 596 710	Blende Für / for Cover 511... Cache 512... Tappo 521... Tapa 524... 	sw	596 273
				br	596 239
				gr	594 585
Für Warnblinkschalter (X) For hazard - warning switch (X) Pour commutateur de clignotans de d'etresse (X) Per interruzioni di luci emergenza (X) Para conmutador de luces de emergencia (X)	12 28	596 252 596 253	Blende Für / for Cover 533... Cache Tappo Tapa 	sw	588 942
Glassockellampe* Wedge base lamp Lampe à socle en verre Lampadina con zoccolo di vetro Lámpara con zócolo de vidrio W2x4,6 d 	12 28	904 404 920 678 1,2 W 40 mA	Einbaurahmen Mounting frame Chassis de montage Cornice di montaggio Cuadro de montaje für Wanddicke 1-2,5 mm 	sw	595 502
Kontrolleuchte Pilot lamp Lampe témoin Spia di controllo Luz piloto Für / for 511... 512... 521... 524... 	12 24	511 500 511 501			sw
Reflektoreinsatz Reflector insert Réflecteur à insérer Riflettore per inserimento Reflector de inserto 	12 24	511 502 511 503	für Wanddicke 4-6 mm 		sw
Kontrolleuchte mit LED Pilot lamp Lampe témoin Spia di controllo Luz piloto Für / for 533... 	12 V 24 V	533 500 533 501	Endstück End piece Pièce de bout Pezzo terminale Pieza terminal Zwischenstück Intermediary piece Pièce intermédiaire Pezzo intermedio Pieza intermedia Endstück End piece Pièce de bout Pezzo terminale Pieza terminal 	sw	594 802
	12 V 24 V	533 502 533 503			594 801

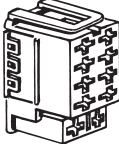
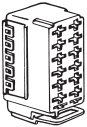
* Bei 24 Volt nur Original SWF-Ersatzteile verwenden, With 24 Volts use original SWF-parts only, En 24 Volts n'utilisez que des pièces originales SWF,
 * Utilizzare solo ricambi SWF per veicolo di 24 Volt, En caso de 24 Voltios hay que utilizar solo repuestos originales de SWF

Benennung Description Dénomination Denominazione Denominación	Volt Volts Volts Volt Voltios	No	Benennung Description Dénomination Denominazione Denominación	Farbe Colour Couleur Colore Color	No
Potentiometer Als Dimmer für Instrumentenbeleuchtung Potentiometer, as dimmer for instrument lighting Potentiomètre, pour le réglage de luminosité des instruments Potenziometro, graduatore per illuminazione degli strumenti Potenciometro, para el reglaje del alumbrado de instrumentos 	17 W	501 338	Steckhülsegehäuse Socket housing Boîtier de connecteur à fiches Alloggiamento manicotti spine Connector 	gr	913 328
			Faston-Steckhülsen DIN 46 340 AMP 42 281-2 	gr	596 289
			für Doppelfeder- kontakte DIN 46 343 for double spring contact pour contact à ressort double per contatto a molla doppia para contacto a muelle doble AMP 927 847 0,5 mm ² -1,0 mm ² 	gr	593 757
			Steckhülsegehäuse Socket housing Boîtier de connecteur à fiches Alloggiamento manicotti spine Connector für Doppelfeder- kontakte DIN 46 343 for double spring contact pour contact à ressort double per contatto a molla doppia para contacto a muelle doble AMP 927 847 0,5 mm ² -1,0 mm ² AMP 927 849 >1,0 mm ² -2,5 mm ² 	gr	589 790

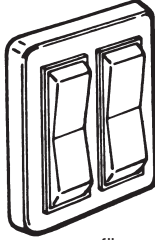
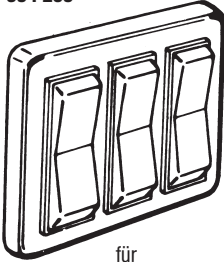
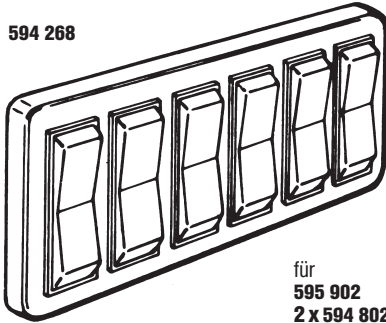
Transparente Schutzkappe				
593 706  Für / for 511... 512...	593 705  für 2 x 594 802	594 269  für 595 502 2 x 594 802 + 594 801	594 268  für 595 902 2 x 594 802 + 4 x 594 801	

Transparente Schutzkappe
 Transparent protection cap
 Capuchon de protection transparent
 Cappuccio di protezione trasparente
 Capuchon protector transparente

mit Rastung
 self-locking
 à enclenchement
 con incastro
 a encaje

Einbauöffnung
 Installation opening
 Ouverture de montage
 Apertura di montaggio
 Apertura de montaje

Einbautiefe max. 60 mm
 Installation depth max. 60 mm
 Profondeur d'installation max. 60 mm
 Profundá dell'apertura di montaggio max. 60 mm
 Profundidad de montaje max. 60 mm

Wanddicke 1-2,5 mm
 Penal thickness 1-2,5 mm
 Ep. de tôte 1-2,5 mm
 Spessore della parete 1-2,5 mm
 Espesor de material 1-1,5 mm

Schalter ohne Symboleinsätze

Switches without inserts
 Interrupteur sans éléments
 Interruttore senza piastrine
 Interruptores sin elementos



<p>511.../512.../521.../524...</p> <p>A Beleuchtung Lighting Eclairage Illuminazione Alumbrado</p> <p>B Suchbeleuchtung Locating lighting Eclairage repère Illuminazione localizzata Alumbrado localización</p> <p>C Such- und Funktionsbeleuchtung Location and function lighting Eclairage repère et service Illuminazione localizzata e servizio Alumbrado localización y servicio</p>	<p>533...</p> <p>B Suchbeleuchtung Locating lighting Eclairage repère Illuminazione localizzata Alumbrado localización</p> <p>C Such- und Funktionsbeleuchtung Location and function lighting Eclairage repère et service Illuminazione localizzata e servizio Alumbrado localización y servicio</p>
Belastung der Schalter / Load / Charge / Carico / Carga	12 V: 16 A 24 V: 8 A

Schaltung Wiring diagram Branchement Schemi elettrici Conexiones	Bestell-Nummer Order No. No. de cde. N. di ordine Referencia	Beleuchtung Lighting Eclairage Illuminazione Alumbrado	Volt Volts Volts Volt Voltios	Betätigungssperre bei* Lock Verrouillage en Blocco attivazione con Con cierre en	Bemerkungen Remarks Observations Osservazioni Observaciones
	511... 512... 521... o. Verr. 524... 533... o. Verr.			EIN ON Service Acceso Servicio	AUS OFF Arrêt Spento Parada

I	Schließer (Arbeitskontakt 0-1)	N/O-contact	Connecteur	Chiusura (contatto lavoro)	Interruptor		
	5.. 000	-	12/24	-	-		gerastet
	5.. 001	A	12	-	-		
	5.. 002	A	24	-	-		
	5.. 003	B	12	-	-		
	5.. 004	B	24	-	-		
	5.. 005	C	12	-	-		
5.. 006	C	24	-	-			
	5.. 007	-	12/24	-	-		getastet
	5.. 008	A	12	-	-		Taster
	5.. 009	A	24	-	-		Non-locking switch
	5.. 010	B	12	-	-		Palpeur
	5.. 011	B	24	-	-		Tastatore
	5.. 167	-	12/24	X	-		gerastet
	5.. 168	A	12	X	-		verriegelt
	5.. 169	A	24	X	-		
	5.. 170	B	12	X	-		
	5.. 171	B	24	X	-		
	5.. 172	C	12	X	-		
5.. 173	C	24	X	-			
	5.. 160	-	12/24	X	-		getastet
	5.. 161	A	12	X	-		verriegelt
	5.. 162	A	24	X	-		Taster
	5.. 163	B	12	X	-		Non-locking switch
	5.. 164	B	24	X	-		Palpeur
	5.. 165	C	12	X	-		Tastatore
5.. 166	C	24	X	-		Pulsador con retorno automático	

* Nur für 511.../512.../524... / For 511.../512.../524... / Seulement pour 511.../512.../524... / Solamente per 511.../512.../524... / Solamente para 511.../512.../524...

Schalter ohne Symboleinsätze

Switches without inserts
 Interrupteur sans éléments
 Interruttore senza piastrine
 Interruptores sin elementos



Schaltung Wiring diagram Branchement Schemi elettrici Conexiones	Bestell-Nummer Order No. No. de cde. N. di ordine Referencia 511... 512... 521... o. Verr. 524... 533... o. Verr.	Beleuchtung Lighting Eclairage Illuminazione Alumbrado	Volt Volts Volts Volt Voltios	Betätigungssperre bei*		Bemerkungen Remarks Observations Osservazioni Observaciones	
				EIN ON Service Acceso Servicio	AUS OFF Arrêt Spento Parada		
	5.. 174	-	12/24	X	X	gerastet	
	5.. 175 5.. 176	A A	12 24	X X	X X	verriegelt	
	5.. 177 5.. 178	B B	12 24	X X	X X		
	5.. 179 5.. 180	C C	12 24	X X	X X		
		5.. 012	-	12/24	-	-	gerastet
		5.. 013 5.. 014	A A	12 24	- -	- -	
5.. 015 5.. 016		B B	12 24	- -	- -		
5.. 017 5.. 018		C C	12 24	- -	- -		
		5.. 127	-	12/24	-	-	getastet
		5.. 128 5.. 129	A A	12 24	- -	- -	
	5.. 130 5.. 131	B B	12 24	- -	- -		
	5.. 249	B	24	-	-	gerastet	
			5.. 019	-	12/24	-	-
5.. 020 5.. 021			A A	12 24	- -	- -	
5.. 022 5.. 023			B B	12 24	- -	- -	
5.. 024 5.. 025	C C		12 24	- -	- -		
	5.. 105		-	12/24	-	-	gerastet
	5.. 106 5.. 107	A A	12 24	- -	- -		
	5.. 108 5.. 109	B B	12 24	- -	- -		
	5.. 110 5.. 111	C C	12 24	- -	- -		

II Wechsler 0-I Change-over contact Changeur Cabiatore Interruptor

* Nur für 511.../512.../524... / For 511.../512.../524... / Seulement pour 511.../512.../524... / Solamente per 511.../512.../524... / Solamente para 511.../512.../524...

Schalter ohne Symboleinsätze

Switches without inserts
 Interrupteur sans éléments
 Interruttore senza piastrine
 Interruptores sin elementos



Schaltung Wiring diagram Branchement Schemi elettrici Conexiones	Bestell-Nummer Order No. No. de cde. N. di ordine Referencia 511... 512... 521... o. Verr. 524... 533... o. Verr.	Beleuchtung Lighting Eclairage Illuminazione Alumbrado	Volt Volts Volts Volt Voltios	Betätigungssperre bei*		Bemerkungen Remarks Observations Osservazioni Observaciones	
				EIN ON Service Acceso Servicio	AUS OFF Arrêt Spento Parada		
	5.. 197	-	12/24	-	-	Taster Non-locking switch Palpeur Tastatore Pulsador con retorno automático	
	5.. 198 5.. 199	A A	12 24	- -	- -		
	5.. 200 5.. 201	B B	12 24	- -	- -		
	5.. 233	-	12/24	X	-		gerastet
	5.. 234 5.. 235	A A	12 24	X X	- -		
	5.. 236 5.. 237	B B	12 24	X X	- -		
	5.. 238 5.. 239	C C	12 24	X X	- -		
	5.. 181	-	12/24	X	X	gerastet	
	5.. 182 5.. 183	A A	12 24	X X	X X		
	5.. 184 5.. 185	B B	12 24	X X	X X		
	5.. 186 5.. 187	C C	12 24	X X	X X		
	5.. 122	-	12/24	-	-	gerastet	
	5.. 123 5.. 124	A A	12 24	- -	- -	+/-Umschalter +/-Switch +/-Commutateur Commutatore +/- Commutador +/-	
	5.. 125 5.. 126	B B	12 24	- -	- -		
	5.. 132	-	12/24	-	-	gerastet	
	5.. 133 5.. 134	A A	12 24	- -	- -	kl. 5-7 max. 5 W Taster	
	5.. 135 5.. 136	B B	12 24	- -	- -	Non-locking switch Palpeur Tastatore Pulsador con retorno automático	
	5.. 291	-	12/24	X	-	getastet	
	5.. 292 5.. 293	A A	12 24	X X	- -		
	5.. 294 5.. 295	B B	12 24	X X	- -		

* Nur für 511.../512.../524... / For 511.../512.../524... / Seulement pour 511.../512.../524... / Solamente per 511.../512.../524... / Solamente para 511.../512.../524...

Schalter ohne Symboleinsätze

Switches without inserts
 Interrupteur sans éléments
 Interruttore senza piastrine
 Interruptores sin elementos



Schaltung Wiring diagram Branchement Schemi elettrici Conexiones	Bestell-Nummer Order No. No. de cde. N. di ordine Referencia 511... 512... 521... o. Verr. 524... 533... o. Verr.	Beleuchtung Lighting Eclairage Illuminazione Alumbrado	Volt Volts Volts Volt Voltios	Betätigungssperre bei*		Bemerkungen Remarks Observations Osservazioni Observaciones
				EIN ON Service Acceso Servicio	AUS OFF Arrêt Spento Parada	
	5.. 752 ▲	-	12/24	-	-	Taster
	5.. 753 ▲ 5.. 754 ▲	B B	12 24	- -	- -	
	5.. 755 ▲ 5.. 756 ▲	C C	12 24	- -	- -	
	III Umschalter 0-I Selector switch Commutateur Commutatore Conmutador					
		5.. 033	-	12/24	-	-
5.. 034 5.. 035		A A	12 24	- -	- -	
5.. 036 5.. 037		B B	12 24	- -	- -	
5.. 038 5.. 039		C C	12 24	- -	- -	
		5.. 040	-	12/24	-	-
	5.. 041 5.. 042	A A	12 24	- -	- -	
	5.. 043 5.. 044	B B	12 24	- -	- -	
	5.. 750 ▲ 5.. 751 ▲	C C	12 24	- -	- -	
		5.. 271	-	12/24	-	-
5.. 272 5.. 273		A A	12 24	- -	- -	
5.. 274 5.. 275		B B	12 24	- -	- -	
5.. 276 5.. 277		C C	12 24	- -	- -	
		5.. 279	-	12/24	-	-
	5.. 280 5.. 281	A A	12 24	- -	- -	
	5.. 282 5.. 283	B B	12 24	- -	- -	
	5.. 299	C	24	-	-	gerastet

▲ Diese Schalter sind nur für Baureihe 533 erhältlich. * Für diese Schalter gelten verminderte Schaltleistungen. Siehe (-)Werte in Tabelle auf Zeichnung A 511.000 Bl.1.
 * Nur für 511.../512.../524... / For 511.../512.../524... / Seulement pour 511.../512.../524... / Solamente per 511.../512.../524... / Solamente para 511.../512.../524...

Schalter ohne Symboleinsätze

Switches without inserts
 Interrupteur sans éléments
 Interruttore senza piastrine
 Interruptores sin elementos



Schaltung Wiring diagram Branchement Schemi elettrici Conexiones	Bestell-Nummer Order No. No. de cde. N. di ordine Referencia 511... 512... 521... o. Verr. 524... 533... o. Verr.	Beleuchtung Lighting Eclairage Illuminazione Alumbrado	Volt Volts Volts Volt Voltios	Betätigungssperre bei* Lock Verrouillage en Blocco attivazione con Con cierre en EIN AUS ON OFF Service Arrêt Acceso Spento Servicio Parada		Bemerkungen Remarks Observations Osservazioni Observaciones
	5..707	C	24	-	-	getastet
IV Schließer-Wechsler 0-I No-contact/Change-over contact Connecteur-changeur Chiusura-cambiatore Interrupitor						
	5..026 5..027 5..028 5..029 5..030 5..031 5..032	- A A B B C C	12/24 12 24 12 24 12 24	- - - - - - -	- - - - - - -	gerastet
	5..202 5..203 5..204 5..205 5..206 5..207 5..208	- A A B B C C	12/24 12 24 12 24 12 24	X X X X X X X	- - - - - - -	Taster I-II Non-locking switch I-II Pulseur I-II Tastatore I-II Pulsador con retorno automático I-II Für 1-tourigen Wischermotor und Waschen For one-speed wiper motor and washing Pour moteur d'essuie-vitre à un tour et lavage Per motori tergicristallo a una velocità e lavaggio Para motor de limpiaparabrisas de una velocidad y lavador
	5..226 5..227 5..228 5..229 5..230 5..231 5..232	- A A B B C C	12/24 12 24 12 24 12 24	- - - - - - -	- - - - - - -	gerastet
	5..095 5..096 5..097 5..098 5..099 5..711 5..712	- A A B B C C	12/24 12 24 12 24 12 24	- - - - - - -	- - - - - - -	gerastet

* Für diese Schalter gelten verminderte Schaltleistungen. Siehe (-)Werte in Tabelle auf Zeichnung A 511.000 Bl.1.

* Nur für 511.../512.../524... / For 511.../512.../524... / Seulement pour 511.../512.../524... / Solamente para 511.../512.../524...

Schalter ohne Symboleinsätze

Switches without inserts
 Interrupteur sans éléments
 Interruttore senza piastrine
 Interruptores sin elementos



Schaltung Wiring diagram Branchement Schemi elettrici Conexiones	Bestell-Nummer Order No. No. de cde. N. di ordine Referencia 511... 512... 521... o. Verr. 524... 533... o. Verr.	Beleuchtung Lighting Eclairage Illuminazione Alumbrado	Volt Volts Volts Volt Voltios	Betätigungssperre bei*		Bemerkungen Remarks Observations Osservazioni Observaciones	
				EIN ON Service Acceso Servicio	AUS OFF Arrêt Spento Parada		
	5.. 085	-	12/24	-	-	gerastet	
	5.. 086 5.. 087	A A	12 24	- -	- -		
	5.. 088 5.. 089	B B	12 24	- -	- -		
	5.. 138 5.. 137	C C	12 24	- -	- -		
	5.. 264	-	12/24	X	-	gerastet	
	5.. 265 5.. 266	A A	12 24	X X	- -	Betätigungssperre I-II Lock I-II Verrouillage I-II Blocco attivazione I-II Con cierre I-II Taster I-II	
	5.. 267 5.. 268	B B	12 24	X X	- -	Non-locking switch I-II Palpeur I-II Tastatore I-II	
	5.. 269 5.. 270	C C	12 24	X X	- -	Pulsador con retorno automático I-II	
	5.. 139	-	12/24	-	-	gerastet	
	5.. 140 5.. 141	A A	12 24	- -	- -		
	5.. 142 5.. 143	B B	12 24	- -	- -		
	5.. 144 5.. 145	C C	12 24	- -	- -		
	5.. 240	-	12/24	X	-	gerastet	
	5.. 241 5.. 242	A A	12 24	X X	- -	Taster I-II Non-locking switch I-II Palpeur I-II Tastatore I-II Pulsadore con retorno automático I-II	
	5.. 243 5.. 244	B B	12 24	X X	- -		
	5.. 245 5.. 246	C C	12 24	X X	- -		
	5.. 248	C	24	X	-	gerastet verriegelt	
	5.. 708	C	24	-	-	gerastet	

* Für diese Schalter gelten verminderte Schaltleistungen. Siehe (-)Werte in Tabelle auf Zeichnung A 511.000 Bl.1.
 * Nur für 511.../512.../524... / For 511.../512.../524... / Seulement pour 511.../512.../524... / Solamente per 511.../512.../524...
 1/10

Schalter ohne Symboleinsätze

Switches without inserts
 Interrupteur sans éléments
 Interruttore senza piastrine
 Interruptores sin elementos



Schaltung Wiring diagram Branchement Schemi elettrici Conexiones	Bestell-Nummer Order No. No. de cde. N. di ordine Referencia 511... 512... 521... o. Verr. 524... 533... o. Verr.	Beleuchtung Lighting Eclairage Illuminazione Alumbrado	Volt Volts Volts Volt Voltios	Betätigungssperre bei* Lock Verrouillage en Blocco attivazione con Con cierre en		Bemerkungen Remarks Observations Osservazioni Observaciones
				EIN ON Service Acceso Servicio	AUS OFF Arrêt Spento Parada	
	5.. 296 5.. 297	C C	12 24	X X	- -	gerastet
V Wechsler 0-I-II Mittelstellung Change-over contact Changeur Cambiatore Cambiador						
	5.. 146	-	12/24	-	-	gerastet
	5.. 147	A	12	-	-	
	5.. 148	A	24	-	-	
	5.. 149	B	12	-	-	
	5.. 150	B	24	-	-	
	5.. 065	-	12/24	-	-	Taster Non-locking switch Palpeur Tastatore Pulsador con retorno automático
	5.. 066	A	12	-	-	
	5.. 067	A	24	-	-	
	5.. 068	B	12	-	-	
	5.. 069	B	24	-	-	
	5.. 748 ▲	C	12	-	-	
	5.. 749 ▲	C	24	-	-	
	5.. 286	-	12/24	X	-	Taster Non-locking switch Palpeur Tastatore Pulsador con retorno automático Betätigungssperre 0-I Lock 0-I Verrouillage 0-I Blocco attivazione 0-I Con cierre 0-I
	5.. 287	A	12	X	-	
	5.. 288	A	24	X	-	
	5.. 289	B	12	X	-	
	5.. 290	B	24	X	-	
	5.. 151	-	12/24	-	-	Taster 0-II Non-Locking switch 0-II Palpeur 0-II Tastatore 0-II Pulsador con retorno automático 0-II
	5.. 152	A	12	-	-	
	5.. 153	A	24	-	-	
	5.. 154	B	12	-	-	
	5.. 155	B	24	-	-	
	5.. 759 ▲	C	12	-	-	
	5.. 758 ▲	C	24	-	-	
	5.. 050	-	12/24	-	-	gerastet
	5.. 051	A	12	-	-	
	5.. 052	A	24	-	-	
	5.. 053	B	12	-	-	
	5.. 054	B	24	-	-	
	5.. 746 ▲	C	12	-	-	
	5.. 747 ▲	C	24	-	-	

① Diese Schalter sind nicht für Baureihe 533 erhältlich.

▲ Diese Schalter sind nur für Baureihe 533 erhältlich. * Für diese Schalter gelten verminderte Schaltleistungen. Siehe (-) -Werte in Tabelle auf Zeichnung A 511.000 Bl.1.

* Nur für 511.../512.../524... / For 511.../512.../524... / Seulement pour 511.../512.../524... / Solamente per 511.../512.../524... / Solamente para 511.../512.../524...

Schalter ohne Symboleinsätze

Switches without inserts
 Interrupteur sans éléments
 Interruttore senza piastrine
 Interruptores sin elementos

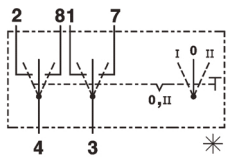
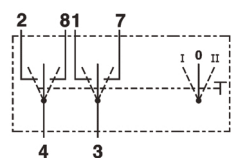
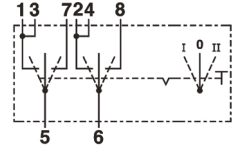
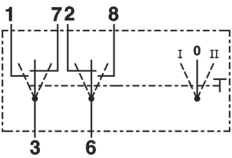
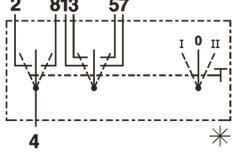
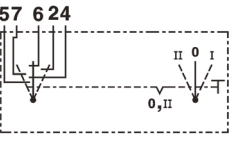
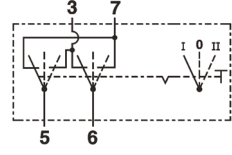

Schaltung Wiring diagram Branchement Schemi elettrici Conexiones	Bestell-Nummer Order No. No. de cde. N. di ordine Referencia 511... 512... 521... o. Verr. 524... 533... o. Verr.	Beleuchtung Lighting Eclairage Illuminazione Alumbrado	Volt Volts Volts Volt Voltios	Betätigungssperre bei* Lock Verrouillage en Blocco attivazione con Con cierre en EIN ON Service Acceso Servicio AUS OFF Arrêt Spento Parada		Bemerkungen Remarks Observations Osservazioni Observaciones
	5.. 060 5.. 061 5.. 062 5.. 063 5.. 064 5.. 744 ▲ 5.. 745 ▲	- A A B B C C	12/24 12 24 12 24 12 24	- - - - - - -		Taster 0-I Non-locking switch 0-I Palpeur 0-I Tastatore 0-I Pulsador con retorno automático 0-I
	5.. 055 5.. 056 5.. 057 5.. 058 5.. 059 5.. 742 ▲ 5.. 743 ▲	- A A B B C C	12/24 12 24 12 24 12 24	- - - - - - -		Taster Non-locking switch Palpeur Tastatore Pulsador con retorno automático
	5.. 070 5.. 071 5.. 072 5.. 073 5.. 074	- A A B B	12/24 12 24 12 24	- - - - -		gerastet
	5.. 211 5.. 212 5.. 213 5.. 214 5.. 215 5.. 216 5.. 217	- A A B B C C	12/24 12 24 12 24 12 24	- - - - - - -		Taster Non-locking switch Palpeur Tastatore Pulsador con retorno automático
	5.. 255 5.. 256 5.. 257 5.. 258 5.. 259 5.. 260 5.. 261	- A A B B C C	12/24 12 24 12 24 12 24	- - - - - - -		Taster Non-locking switch Palpeur Tastatore Pulsador con retorno automático
	5.. 768 5.. 769 5.. 770 5.. 771 5.. 772	- B B C C	12/24 12 24 12 24	- - - - -		Taster 0-I
VI Doppelwechsler I-0-II Double change-over Changeur double Cabiatore doppio Interruptor						
	5.. 100 5.. 101 5.. 102 5.. 103 5.. 104	- A A B B	12/24 12 24 12 24	- - - - -		gerastet

▲ Diese Schalter sind nur für Baureihe 533 erhältlich. * Für diese Schalter gelten verminderte Schaltleistungen. Siehe ()-Werte in Tabelle auf Zeichnung A 511.000 Bl.1.
 * Nur für 511.../512.../524... / For 511.../512.../524... / Seulement pour 511.../512.../524... / Solamente per 511.../512.../524... / Solamente para 511.../512.../524...

Schalter ohne Symboleinsätze

Switches without inserts
 Interrupteur sans éléments
 Interruttore senza piastrine
 Interruptores sin elementos

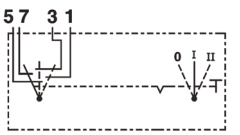
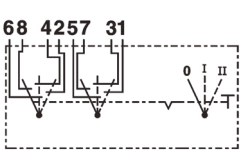
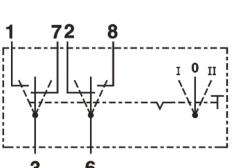
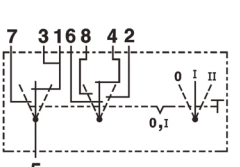
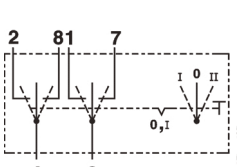
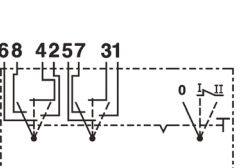

Schaltung Wiring diagram Branchement Schemi elettrici Conexiones	Bestell-Nummer Order No. No. de cde. N. di ordine Referencia 511... 512... 521... o. Verr. 524... 533... o. Verr.	Beleuchtung Lighting Eclairage Illuminazione Alumbrado	Volt Volts Volts Volt Voltios	Betätigungssperre bei* Lock Verrouillage en Blocco attivazione con Con cierre en EIN ON Service Acceso Servicio		Bemerkungen Remarks Observations Osservazioni Observaciones
	5.. 045 5.. 046 5.. 047 5.. 048 5.. 049	- A A B B	12/24 12 24 12 24	- - - - -		gerastet Für 2-tourige Wischermotoren For two-speed wiper motor Per motori tergicristallo a due velocità Pour moteur d'essuie-vitre à deux tours Para motor de limpiaparabrisas de dos velocidades
	5.. 090 5.. 091 5.. 092 5.. 093 5.. 094 5.. 709 ▲ 5.. 710 ▲	- A A B B C C	12/24 12 24 12 24 12 24	- - - - - - -		gerastet
	5.. 700 5.. 701 5.. 702 5.. 703 5.. 704 5.. 705 5.. 706	- A A B B C C	12/24 12 24 12 24 12 24	- - - - - - -		gerastet
	5.. 715 5.. 716 5.. 717 5.. 718 5.. 719 5.. 720 5.. 721	- A A B B C C	12/24 12 24 12 24 12 24	- - - - - - -		gerastet
	5.. 726 5.. 725 5.. 724 5.. 723 5.. 722	- A A B B	12/24 12 24 12 24	- - - - -		gerastet
	5.. 727 5.. 728 5.. 729 5.. 730 5.. 731	- A A B B	12/24 12 24 12 24	X X X X X		gerastet Betätigungssperre I-II Lock I-II Verrouillage I-II Blocco attivazione I-II Con cierre I-II Taster I-II Non-Locking switch I-II Palpeur I-II Tastatore I-II Pulsador con retorno automático I-II

▲ Diese Schalter sind nur für Baureihe 533 erhältlich. * Für diese Schalter gelten verminderte Schaltleistungen. Siehe ()-Werte in Tabelle auf Zeichnung A 511.000 Bl.1.
 * Nur für 511.../512.../524... / For 511.../512.../524... / Seulement pour 511.../512.../524... / Solamente per 511.../512.../524... / Solamente para 511.../512.../524...

Schalter ohne Symboleinsätze

Switches without inserts
 Interrupteur sans éléments
 Interruttore senza piastrine
 Interruptores sin elementos



Schaltung Wiring diagram Branchement Schemi elettrici Conexiones	Bestell-Nummer Order No. No. de cde. N. di ordine Referencia 511... 512... 521... o. Verr. 524... 533... o. Verr.	Beleuchtung Lighting Eclairage Illuminazione Alumbrado	Volt Volts Volts Volt Voltios	Betätigungssperre bei*		Bemerkungen Remarks Observations Osservazioni Observaciones	
				EIN ON Service Acceso Servicio	AUS OFF Arrêt Spento Parada		
	5.. 732	-	12/24	-	-	gerastet	
	5.. 733 5.. 734	A A	12 24	- -	- -		
	5.. 735 5.. 736	B B	12 24	- -	- -		
	5.. 737 5.. 738	C C	12 24	- -	- -		
	5.. 739	C	12	X	-	gerastet Betätigungssperre 0-I Lock 0-I Verrouillage 0-I Blocco attivazione 0-I Con cierre 0-I Taster 0-I Non-Locking switch 0-I Palpeur 0-I Tastatore 0-I Pulsador con retorno automático 0-I	
	5.. 740	C	12	X	-	Taster Non-Locking switch Palpeur Tastatore Pulsador con retorno automático Betätigungssperre 0-I Lock 0-I Verrouillage 0-I Blocco attivazione 0-I Con cierre 0-I	
	5.. 766 ▲	-	12/24	-	-		
	5.. 765 ▲	B	12	-	-	Taster I-II Non-locking switch I-II Palpeur I-II	
	5.. 764 ▲	B	24	-	-	Tastatore I-II	
	5.. 762 ▲	C	12	-	-	Pulsador con	
	5.. 763 ▲	C	24	-	-	retorno automático I-II	
VII Wechselschalter – Taster Kombination 0-I-II change-over contact/non-locking switch com bination Inverseur – Touche-Combinaison Interruttore cambio – Combinazione tastatore Interruptor de cambio – Combinado							
	5.. 112 5.. 113 5.. 114 5.. 115 5.. 116 5.. 713 ▲ 5.. 714 ▲	- A A B B C C	12/24 12 24 12 24 12 24	- - - - - - -	- - - - - - -	Taster I-II Non-locking switch I-II Palpeur I-II Tastatore I-II Pulsador con retorno automático I-II Für 1-tourigen Wischermotor und Waschen For one-speed wiper motor and washing Pour moteur d'essuie-vitre à un tour et lavage Per motori tergicristallo a una velocità e lavaggio Para motor de limpiaparabrisas de una velocidad y lavador	

▲ Diese Schalter sind nur für Baureihe 533 erhältlich. * Für diese Schalter gelten verminderte Schaltleistungen. Siehe ()-Werte in Tabelle auf Zeichnung A 511.000 Bl.1.
 * Nur für 511.../512.../524... / For 511.../512.../524... / Seulement pour 511.../512.../524... / Solamente per 511.../512.../524... / Solamente para 511.../512.../524...

Schalter ohne Symboleinsätze

Switches without inserts
 Interrupteur sans éléments
 Interruttore senza piastrine
 Interruptores sin elementos



Schaltung Wiring diagram Branchement Schemi elettrici Conexiones	Bestell-Nummer Order No. No. de cde. N. di ordine Referencia 511... 512... 521... o. Verr. 524... 533... o. Verr.	Beleuchtung Lighting Eclairage Illuminazione Alumbrado	Volt Volts Volts Volt Voltios	Betätigungssperre bei*		Bemerkungen Remarks Observations Osservazioni Observaciones	
				Lock Verrouillage en Blocco attivazione con Con cierre en	EIN ON Service Acceso Servicio		AUS OFF Arrêt Spento Parada
	5.. 117	-	12/24	-	-	Taster I-II Non-locking switch I-II Palpeur I-II Tastatore I-II Pulsador con retorno automático I-II	
	5.. 118	A	12	-	-		
	5.. 119	A	24	-	-		
	5.. 120	B	12	-	-		
	5.. 121	B	24	-	-		
VIII 2 Schließer in Reihe 0-I-II 2 No-contacts in series 2 Connecteur en série 2 Chiusure di serie 2 Interruptores							
	5.. 080	-	12/24	-	-	gerastet	
	5.. 081	A	12	-	-		
	5.. 082	A	24	-	-		
	5.. 083	B	12	-	-		
	5.. 084	B	24	-	-		
5.. 209	C	12	-	-			
5.. 210	C	24	-	-			
	5.. 075	-	12/24	-	-	gerastet	
	5.. 076	A	12	-	-		
	5.. 077	A	24	-	-		
	5.. 078	B	12	-	-		
	5.. 079	B	24	-	-		
IX Spezialschaltung (ausschließlich für Warnblinken) Special switch (only for hazard-warning) Connection spéciale (exclusivement pour clignotants de détresse) Interruzioni speciali (esclusivamente per luci emergenza) Conexion especial (solo para luces de advertencia)							
	5.. 218	C	24	-	-	gerastet 10 A	
	5.. 220	C	24	-	-		getastet 10 A, Taster Non-locking switch Palpeur Tastatore Pulsador con retorno automático
	5.. 219	C	24	X	-		
	5.. 247	C	12	-	-		
	5.. 262	C	12	-	-		
5.. 263	C	24	-	-			

① Diese Schalter sind nicht für Baureihe 533 erhältlich. * Für diese Schalter gelten verminderte Schaltleistungen. Siehe (-)-Werte in Tabelle auf Zeichnung A 511.000 Bl.1.
 * Nur für 511.../512.../524... / For 511.../512.../524... / Seulement pour 511.../512.../524... / Solamente per 511.../512.../524... / Solamente para 511.../512.../524...

Schalter ohne Symboleinsätze

Switches without inserts
 Interrupteur sans éléments
 Interruttore senza piastrine
 Interruptores sin elementos



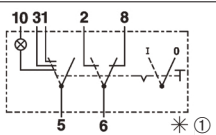
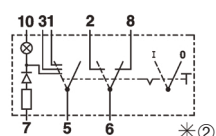
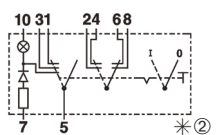
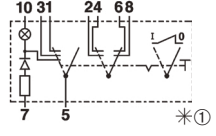
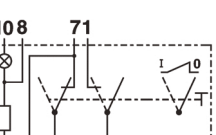







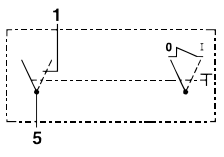



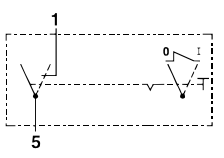



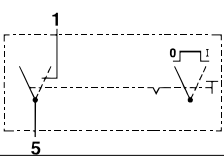
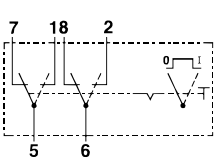



Schaltung Wiring diagram Branchement Schemi elettrici Conexiones	Bestell-Nummer Order No. No. de cde. N. di ordine Referencia 511... 512... 521... o. Verr. 524... 533... o. Verr.	Beleuchtung Lighting Eclairage Illuminazione Alumbrado	Volt Volts Volts Volt Voltios	Betätigungssperre bei*		Bemerkungen Remarks Observations Osservazioni Observaciones
				EIN ON Service Acceso Servicio	AUS OFF Arrêt Spento Parada	
	5.. 190 5.. 191	C C	12 24	- -	- -	getastet Kl. 6-8 und 6-2 = 10 A sonst. 5 A
	5.. 192 5.. 193	C C	12 24	- -	- -	gerastet Kl. 6-8 und 6-2 = 10 A sonst. 5 A
	5.. 194 5.. 195	C C	12 24	- -	- -	gerastet Kl. 6-8 und 6-2 = 10 A sonst. 5 A
	5.. 278	C	24	X	-	gerastet verriegelt
	5.. 250	C	24	X	-	getastet verriegelt

① Diese Schalter sind nicht für Baureihe 533 erhältlich.

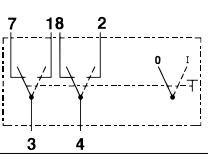
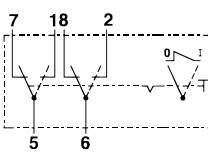
② Diese sind bei Baureihe 533 mit roter LED. * Für diese Schalter gelten verminderte Schaltleistungen. Siehe ()-Werte in Tabelle auf Zeichnung A 511.000 Bl.1.

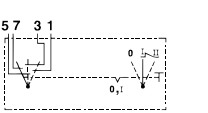
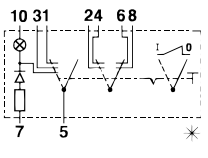
* Nur für 511.../512.../524... / For 511.../512.../524... / Seulement pour 511.../512.../524... / Solamente per 511.../512.../524... / Solamente para 511.../512.../524...

Schalterdaten							Einsatzdaten				
Schaltung	Bestell-Nr.	Bel.	Volt	Betätigungs- sperre bei		Bemerkung	Grund- schaltung	Symbol	Benennung	Farbe	Symbol- lage
				EIN	AUS						
Schließer (Arbeitskontakt 0-1) N/O-contact											
	533558	B	12	X	-	getastet touched	511163		Zusatzgerät öffnen Open accessory unit	rt	0
	533556	B	12	X	-	getastet touched	511163		Schaufel entsperren Bucket loader unlocked	rt	0
	533561	B	24	X	-	getastet touched	511164		Schaufel entsperren Bucket loader unlocked	gr	0
	533571	B	24	X	-	gerastet punched	511171		Freigabe Abstützung Unlock support	gr	0
	533557	B	24	X	-	gerastet punched	511171	-	-	gr	0
	533576	B	24	X	-	gerastet punched	511171		Differential-Sperre Differential lock	gr	0
	533567	B	24	X	-	gerastet punched	511171	WC	WC WC	gr	0
	533568	B	24	X	-	gerastet punched	511171		Batterie Battery	gr	0
	533550	B	24	X	X	gerastet punched	511178	-	-	gr	0
Wechsler 0-1 change-over contact											
	533570	B	12	X	X	gerastet punched	511184		Lenkautomat Automatic steering device	gr	0
	533565	B	12	X	X	gerastet punched	511184		Lenkautomat Automatic steering device	gn	0
	533569	B	12	X	X	gerastet punched	511184		Gang 2 Gear 2	gr	0
	533562	B	12	X	X	gerastet punched	511184	III	Stufe 3 Grade 3	gr	0
	533564	B	12	X	X	gerastet punched	511184		Schnell Fast	gn	0
	533572	B	12	X	X	gerastet punched	511184		Schnell Fast	gr	0
	533566	B	12	X	X	gerastet punched	511184		Gang 2 Gear 2	gn	0
	533575	B	24	X	X	gerastet punched	511185	-	-	rt	0

Schalterdaten							Einsatzdaten				
Schaltung	Bestell-Nr.	Bel.	Volt	Betätigungs- sperre bei		Bemerkung	Grund- schaltung	Symbol	Benennung	Farbe	Symbol- lage
				EIN	AUS						
	533577	B	24	-	-	gerastet punched	511201	-	-	rt	0
	533560	B	12	X	-	gerastet punched	511236	III	Stufe 3 Grade 3	gr	0
	533574	B	12	X	-	gerastet punched	511236	IV	Stufe 4 Grade 4	gr	0
	533573	B	12	X	-	gerastet punched	511236		Motor Stufe 3 Motor Grade 3	gr	0
Schließer-Wechsler 0-I No-contact/Change-over contact											
	533551	B	12	X	-	getastet touched	511205	-	-	bl	0
Spezierschaltung Special switch											
	533554	B	24	X	-	gerastet punched	511278		Schaufel ent- sperren Bucket loader unlocked	gr	0
	533555	B	24	X	-	gerastet punched	511278		Schwenk- bremse Anti-slewing brake	gr	0
	533552	B	24	X	-	gerastet punched	511278	-	-	gr	0
	533553	B	24	X	-	gerastet punched	511278		Parkbremse Parking brake	rt	0

Einsätze (nicht für 533 . . .)

Inserts (not for 533 . . .)

Éléments (auf 533 . . .)

Piastrine (non per . . .)

Elementes (non vale . . .)



Symbol Symbol Symbole Simbolo Símbolo	Benennung Description Dénomination Denominazione Denominación	Farbe Color Couleur Colore Color	Symbollage Mounting Pos. demon. Montaggio Montaje				Bestell-Nr. Order No. No. de cde N. di ordine Referencia	Symbol Symbol Symbole Simbolo Símbolo	Benennung Description Dénomination Denominazione Denominación	Farbe Color Couleur Colore Color	Symbollage Mounting Pos. demon. Montaggio Montaje				Bestell-Nr. Order No. No. de cde N. di ordine Referencia										
			normal	90°	180°	270°					normal	90°	180°	270°											
I. Einsätze ohne Symbol Inserts without symbol Utilisation sans symbole Inserti senza simbolo Plaquita sin simbolo														hellrot light red rouge clair rosso chiaro rojo claro	hrt										593 270
	farblos matt colourless matt sans couleur mat incolore pallido descolorido apagado	fbl						dunkelrot dark-red rouge sombre rosso scuro rojo oscuro	drt									594 646							
	grün green vert verde verde	gn						gelb yellow jaune giallo amarillo	gb									596 610							
	hellgrün light green vert clair verde chiaro verde claro	hgn						hellgelb light yellow jaune clair giallo chiaro amarillo claro	hgb									593 271							
	dunkelgrün dark-green vert foncé verde scuro verde oscuro	dgn						weiß white blanc bianco blanco	w									596 100							
	blau blue bleu blu azul	bl						normal 90° 180° 270° 																	
	schwarz* black noir nero negro	sw*																596 620							
	orange orange orange arancio naranja	or																596 230							
	rot red rouge rosso rojo	rt																596 615							

F = Rückseite bedruckt

O = Rückseite bedruckt mit Funktionsbeleuchtung

Einsätze (nicht für 533 . . .)













Inserts (not for 533 . . .)

Éléments (auf 533 . . .)

Piastrine (non per . . .)

Elementes (non vale . . .)



Symbol Symbol Symbole Simbolo Símbolo	Benennung Description Dénomination Denominazione Denominación	Farbe Color Couleur Colore Color	Symbollage Mounting Pos. demon. Montaggio Montaje				Bestell-Nr. Order No. No. de cde N. di ordine Referencia	Symbol Symbol Symbole Simbolo Símbolo	Benennung Description Dénomination Denominazione Denominación	Farbe Color Couleur Colore Color	Symbollage Mounting Pos. demon. Montaggio Montaje				Bestell-Nr. Order No. No. de cde N. di ordine Referencia					
			normal	90° ↘	180° ↔	270° ↙					normal	90° ↘	180° ↔	270° ↙						
II. Wischen-Waschen Wipe-Wash Essuie-vitre/lave-vitre Tergivetro-Lavaggio Limpiaparabrisas-Lavaparabrisas																				
	Heckscheiben - Intervallwischen Rear window interval wiping Essuie-vitre intermittent de la lunette AR Tergilunotto intermittente Limpia-luneta intermitente	gn		X					Scheibenwischer/wascher Windscreen wiper/washer Essuie et lave-vitre Tergilavavetro Limpia-y lavaparabrisas	gb/w	X				595 107					
										gn	X				596 603					
												X			596 415					
													X		595 117					
										sw		X			592 787					
													X		594 763					
										sw/w	X				596 801					
											O				591 632					
	Heckscheibenwascher Rear window washer Lave-vitre de la lunette AR Lavalunotto Lava-cristal posterior	gn	X						Scheinwerferwascher Headlamp washer Lave-projecteur Lavafari Lava-faros	gn	X				595 112					
		w	X							sw/w	O				593 603					
	Heckscheibenwischer Rear window wiper Essui-vitre de la lunette AR Tergilunotto Limpia-cristal posterior	gn	X						Scheinwerferwischer/wascher Headlamp wiper/washer Nettoyeur de projecteur Tergilavafari Limpia-y lava-faros	gn	X				596 647					
				X									X		596 408					
					X					sw/w	O				591 933					
	Heckscheibenwischer Rear window wiper Essui-vitre de la lunette AR Tergilunotto Limpia-cristal posterior	gn		X					Seitenwischer Sidewindowwiper	hgn			X		592 462					
		sw			X															
		sw/w	O																	
		w	X																	
		gn	X																	
		or			X															
	Heckscheibenwischer/-wascher Rear window wiper/washer Essuie et lave-vitre AR Tergilavalunotto Limpia-y lava-cristal posterior	gn				X														
		sw/w	O																	
						F														
		w	X																	
	Intervallwischer Intermittant wiper Essuie-vitre intermittent Tergivetro intermittente Limpezia intermitente	gn	X																	
				X																
					X															
	Scheibenwascher Windscreen washer Lave-vitre Lavavetro Lavaparabrisas	gb/w	X																	
			X																	
		gn		X																
					X															
						X														
		hgn			X															
		sw	X																	
					X															
		sw/w				F														
	Scheibenwischer Windscreen wiper Essuie-vitre Tergivetro Limpiaparabrisas	gn	X																	
				X																
					X															
						X														
		hgn			X															
			X																	
			O																	
		sw/w	F																	
					X															
						F														

F = Rückseite bedruckt

O = Rückseite bedruckt mit Funktionsbeleuchtung

Einsätze (nicht für 533 . . .)

Inserts (not for 533 . . .)

Éléments (auf 533 . . .)

Piastrine (non per . . .)

Elementes (non vale . . .)



Symbol Symbol Symbole Simbolo Símbolo	Benennung Description Dénomination Denominazione Denominación	Farbe Color Couleur Colore Color	Symbollage Mounting Pos. demon. Montaggio Montaje				Bestell-Nr. Order No. No. de cde N. di ordine Referencia	Symbol Symbol Symbole Simbolo Símbolo	Benennung Description Dénomination Denominazione Denominación	Farbe Color Couleur Colore Color	Symbollage Mounting Pos. demon. Montaggio Montaje				Bestell-Nr. Order No. No. de cde N. di ordine Referencia				
			normal	90° ↘	180° ↖	270° ↙					normal	90° ↘	180° ↖	270° ↙					
III. Beleuchtung Lighting Eclairage Illuminazione Alumbrado																			
	Abblendlicht Dipped beam Feux de croisement Anablagliante Luz de cruce	gn	X				596 303		Arbeitsleuchte verstellen Working light change position	hgn	X				589 193				
					X		593 303												
		hgn			X		592 480												
		sw/w			F		591 373												
	Achtung geöffnet Warning open	rt	X				592 170		Arbeitslicht Servicelamp Projecteur de travail Faro da lavoro Luz de trabajo	gb/w			X		593 631				
	Arbeitsbeleuchtung Work lamp Eclairage du travail Illuminazione di lavoro Luz de trabajo	gb/sw	X				594 475		Arbeitscheinwerfer heben-senken Service lamp Up-Down Projecteur travail Lever-Desc. Proiettore da lavoro in alto-in basso Faros de trabajo Subir-Bajar	gb/w			X		592 896				
		gb/w	X				595 401												
				X			591 287												
					X		594 714												
		gn	X				594 767												
				X			589 840												
					X		594 768												
						X	594 428												
		or	X				596 137												
				X			589 939												
					X		594 705												
		sw		X			595 426												
		sw/or	F				589 064												
			O				591 668												
sw/w		O			591 666														
			F		592 686														
	Arbeitsbeleuchtung Work lamp Eclairage du travail Illuminazione di lavoro Luz de trabajo	gb/sw	X				594 474		Arbeitscheinwerfer vorn Service lamp in front Projecteur de travail AV Proiettore da lavoro anteriore Faros de trabajo delanteros	gn		X			596 473				
		gb/w	X				595 402					X		594 401					
				X			591 878						X		596 134				
		gn	X				596 313							X	596 601				
				X			594 738												
		hgn	X				594 723					X			594 493				
					X		592 355						X		595 105				
		or	X				596 151								592 695				
				X			589 938						X		596 654				
					X		594 433							X	591 879				
						X	593 070								596 336				
		sw	X				596 312												
					X		596 192												
		sw/or	F				589 065												
			O				591 669												
		sw/w		O			591 667												
				F			592 772												
					F		591 036												
						F	592 352												

F = Rückseite bedruckt

O = Rückseite bedruckt mit Funktionsbeleuchtung

Einsätze (nicht für 533 . . .)

Inserts (not for 533 . . .)

Éléments (auf 533 . . .)

Piastrine (non per . . .)

Elementes (non vale . . .)



Symbol Symbol Symbole Simbolo Símbolo	Benennung Description Dénomination Denominazione Denominación	Farbe Color Couleur Colore Color	Symbollage Mounting Pos. demon. Montaggio Montaje				Bestell-Nr. Order No. No. de cde N. di ordine Referencia	Symbol Symbol Symbole Simbolo Símbolo	Benennung Description Dénomination Denominazione Denominación	Farbe Color Couleur Colore Color	Symbollage Mounting Pos. demon. Montaggio Montaje				Bestell-Nr. Order No. No. de cde N. di ordine Referencia	
			normal	90° ↘	180° ↙	270° ↻					normal	90° ↘	180° ↙	270° ↻		
	Fahrerlicht Driver light	sw/w	O					Innenbeleuchtung Interior light Plafonnier Illuminazione interna Alumbrado interior	gn	X				596 641		
				X							X			593 305		
					X							X		593 678		
									sw/w	X				596 175		
										O				593 610		
	Fahrerplatzbeleuchtung Driving seat lighting Plafonnier conducteur Illuminazione poste guida Alumbr. puesto conductor	gn	X					Innenbeleuchtung mittel Interior light: medium Plafonnier moyen éclairément Illuminazione interna media Alumbr. interior medio	gn	X				596 640		
						X						X		596 799		
	Fernlicht High beam Phares Abbagliante Luz de carretera	bl	X					Innenbeleuchtung schwach Interior light: dim Plafonnier faible éclairément Illuminazione interna debole Alumbr. interior débil	gn	X				596 639		
			X													
		dbl	X						sw/w	O					593 609	
			X		X											
		gn	X													596 189
		hbl	X													593 189
		sw/w	O													592 391
sw/w	O													592 305		
	Fern-/Abblendlicht High / dipped beam	bl	X					Instrumentenbeleuchtung Instrument lighting	gn	X					595 439	
	Flutlicht Work light	hgn	X					Instrumentenbeleuchtung Instrument lighting Eclairage tableau de bord Illuminazione strumentazione Alumbr. instrumentos	gn	X					595 100	
	Frontscheinwerfer Front light	gn			X			Instrumentenbeleuchtung Instrument lighting Eclairage tableau de bord Illuminazione strumentazione Alumbr. instrumentos	gn	X					596 636	
											X			592 860		
												X		596 418		
													X	594 751		
	Hauptlicht Mainlight Eclairage général Luce principale Alumbrado principal	gn	X					Kofferraumbeleuchtung Trunk light Éclairage du coffre Illuminazione bagagliaio Luz del maletero	gn	X					595 965	
				X										596 651		
					X									595 182		
						X								595 102		
							X							594 800		
		sw			X			Korntankbeleuchtung Grain tank light	hgn			X			595 418	
			X											596 621		
			O											591 640		
		sw/w	F											593 613		
				F										592 694		
					O									591 638		
	Hauptlicht aus Mainlight Out	gn	X					Ladeflächebeleuchtung Loading floor lamp	gn	X					591 689	

F = Rückseite bedruckt

O = Rückseite bedruckt mit Funktionsbeleuchtung

Einsätze (nicht für 533 . . .)

Inserts (not for 533 . . .)

Éléments (auf 533 . . .)

Piastrine (non per . . .)

Elementes (non vale . . .)



Symbol Symbol Symbole Simbolo Símbolo	Benennung Description Dénomination Denominazione Denominación	Farbe Color Couleur Colore Color	Symbollage Mounting Pos. demon. Montaggio Montaje				Bestell-Nr. Order No. No. de cde N. di ordine Referencia	Symbol Symbol Symbole Simbolo Símbolo	Benennung Description Dénomination Denominazione Denominación	Farbe Color Couleur Colore Color	Symbollage Mounting Pos. demon. Montaggio Montaje				Bestell-Nr. Order No. No. de cde N. di ordine Referencia			
			normal	90° ↘	180° ↔	270° ↙					normal	90° ↘	180° ↔	270° ↙				
	Ladeflächenbeleuchtung Loading floor lamp Eclairage de la plateforme Illuminazione cassone di carico Alumbrado plataforma	sw/w				0	592 638		Leuchten Linienschilder Lights line signs	sw/w				0	592 123			
	Ladeflächenbeleuchtung Loading floor lamp Eclairage de la plateforme Illuminazione cassone di carico Alumbrado plataforma	gb/w	X				595 847		Licht Lamp Phares Luce Luz	gn	X				596 629			
				X							594 746		X				593 304	
		gn		X						594 721			X				596 400	
					X						594 779				X			594 782
						X					594 749	sw	X					596 619
		sw/w	0							592 054								
			Ladenflächenlicht Light for loading area	gn	X						592 164		Lichtreduzierung Light reduction Réduction de lumière Riduzione luce Reducción de la luz	w	X			
	Laderaumbeleuchtung Cargo compartment lighting Eclairage plate-forme Illuminazione vano di carico Alumbrado del compartimento de carga	gb/w	X				594 485		Linienanzeige Line indicator Indicateur linéaire Indicatore lineare Indicador de líneas	gn	X				595 143			
				X							592 870		X				593 315	
	Lampenprüfung Lamp test Contrôle des lampes Controllo lampada Comprobación de lámparas	gn	X				596 110		Nebelscheinwerfer Fog lamp	gn	X				590 588			
				X							596 123		Nebelscheinwerfer Fog lamp Feux de brouillard avant Fendinebbia Faros antiniebla	sw/w			F	592 685
	Lampenprüfung Lamp test Contrôle des lampes Controllo lampada Comprobación de lámparas	gn				X	594 781		Nebelscheinwerfer Fog lamp Feux de brouillard avant Fendinebbia Faros antiniebla	sw/w	0							593 611
															X			
	Leselampe Reading light	sw/w	0				592 131		Nebelscheinwerfer Fog lamp Feux de brouillard avant Fandinebbia Faros antiniebla	gn		X			595 181			
																X		
	Leselampe Reading light Lampe de lecture Luce di lettura Luz de lectura	gn	X				596 638		Nebelscheinwerfer Fog lamp Feux de brouillard avant Fandinebbia Faros antiniebla	gn	X				594 799			
												sw/w	0					593 612
	Leselampe Reading light Lampe de lecture Luce di lettura Luz de lectura	gn	X				596 638		Nebelscheinwerfer Fog lamp Feux de brouillard avant Fandinebbia Faros antiniebla	gn	X				595 433			

F = Rückseite bedruckt

0 = Rückseite bedruckt mit Funktionsbeleuchtung

Einsätze (nicht für 533 . . .)

Inserts (not for 533 . . .)

Éléments (auf 533 . . .)

Piastrine (non per . . .)

Elementes (non vale . . .)



Symbol Symbol Symbole Simbolo Símbolo	Benennung Description Dénomination Denominazione Denominación	Farbe Color Couleur Colore Color	Symbollage Mounting Pos. demon. Montaggio Montaje				Bestell-Nr. Order No. No. de cde N. di ordine Referencia	Symbol Symbol Symbole Simbolo Símbolo	Benennung Description Dénomination Denominazione Denominación	Farbe Color Couleur Colore Color	Symbollage Mounting Pos. demon. Montaggio Montaje				Bestell-Nr. Order No. No. de cde N. di ordine Referencia
			normal	90°	180°	270°					normal	90°	180°	270°	
	Nebelschlußleuchte Fog warning lamp	gb/w	X							gb/sw	X				590 480
										gb/w	X				596 426
												X			594 715
										gn	X				596 628
												X			595 188
										hgn	X		X		596 406
										or		X			594 722
													X		592 373
										sw/w				X	592 916
											O				593 067
										sw/w				O	591 662
														F	591 660
															592 771
	Nebelschlußleuchte Fog warning lamp	gb/sw	X							gb	X				591 345
			X												596 609
				X											595 180
					X										596 404
						X									594 798
			X							gn	X				596 626
					X										596 417
	Parklicht Parking light Feux de stationnement Luci di parcheggio Luz de estacionamiento	gn	X												596 145
						X									594 717
	Positionsleuchte Position lamp Feux de position Luci di posizione Luz de posición	bl	X												594 484
	Positionsleuchte Position lamp Feux de position Luci di posizione Luz de posición	gn	X												596 424
	Prüfer Tester Contrôleur Apparecchio in prova Comprobador	gn	X												596 184
							X								593 308
	Punktlicht Spot light	gb/sw	X												592 187
	Rundumkennleuchte Rotary beacon Girophare Lampeggiatore avvert. rot. Luz rot. advertencia	gb/sw	X							gb	X				591 690
										gb/sw	X				591 346
	Rundumkennleuchte Rotary beacon Girophare Lampeggiatore avvert. rot. Luz rot. advertencia	gb/sw	X							gn	X				592 348
										gn			X		592 876
										hgn			X		589 926
										or	X				592 392
										sw/w				F	595 113
															591 341
	Schlauch Arbeitsleuchte Windlass light	gb	X												590 634
	Tarnscheinwerfer Masked headlamp Projecteur camouflé Fari camuffati Faros ocultos	gn	X												596 655
	Top - Fernlicht Front light	gn	X												590 682
	Umschaltung Arbeitslicht Change-over working light	gn	X												591 552

F = Rückseite bedruckt

O = Rückseite bedruckt mit Funktionsbeleuchtung

Einsätze (nicht für 533 . . .)

Inserts (not for 533 . . .)

Éléments (auf 533 . . .)

Piastrine (non per . . .)

Elementes (non vale . . .)



Symbol Symbol Symbole Simbolo Símbolo	Benennung Description Dénomination Denominazione Denominación	Farbe Color Couleur Colore Color	Symbollage Mounting Pos. demon. Montaggio Montaje				Bestell-Nr. Order No. No. de cde N. di ordine Referencia	Symbol Symbol Symbole Simbolo Símbolo	Benennung Description Dénomination Denominazione Denominación	Farbe Color Couleur Colore Color	Symbollage Mounting Pos. demon. Montaggio Montaje				Bestell-Nr. Order No. No. de cde N. di ordine Referencia							
			normal	90° ↷	180° ↷	270° ↷					normal	90° ↷	180° ↷	270° ↷								
	Warnlicht Hazard warning Attention Attenzione Atención	drt		X			594 665															
		hrt	X				593 178															
		or	X				596 170															
		rt	X				596 191															
			X				594 739															
				X			595 417															
						X	594 408															
		rt/w			F		591 337															
		sw/w	O				592 178															
w/rt	F				589 930																	
	Warnlicht Hazard warning Signal détresse Luci d'emergenza Señal de emergencia	rt	X				596 614															
			X				595 191															
	Warnung aus Warning off	gb	X				589 708															
	Warnung rechts Warning right	gb	X				589 706															
	Zusatzscheinwerfer Additional headlight	bl	X				591 688															

F = Rückseite bedruckt

O = Rückseite bedruckt mit Funktionsbeleuchtung

Einsätze (nicht für 533 . . .)

Inserts (not for 533 . . .)

Éléments (auf 533 . . .)

Piastrine (non per . . .)

Elementes (non vale . . .)



Symbol Symbol Symbole Simbolo Símbolo	Benennung Description Dénomination Denominazione Denominación	Farbe Color Couleur Colore Color	Symbollage Mounting Pos. demon. Montaggio Montaje				Bestell-Nr. Order No. No. de cde N. di ordine Referencia	Symbol Symbol Symbole Simbolo Símbolo	Benennung Description Dénomination Denominazione Denominación	Farbe Color Couleur Colore Color	Symbollage Mounting Pos. demon. Montaggio Montaje				Bestell-Nr. Order No. No. de cde N. di ordine Referencia									
			normal	90° ↘	180° ↙	270° ↻					normal	90° ↘	180° ↙	270° ↻										
IV. Lüftung-Heizung-Gebläse Heating & Ventilation Aération-Chauffage-Ventilation Ventilazione-Riscaldamento Ventilación-Calefacción-Sopiadores														Gebläse Blower	hrt		X							591 505
OUTER F INNER	Außentemperatur Outside temperature Température extérieur Temperatura esterna Temperatura exterior	gn	X									594 464		Gebläse Blower	sw/gb			F				591 339		
														sw/w			F			591 615				
	Beheizter Rückspiegel Exterior rear view mirror heating	sw/w	O											Gebläse Blower Ventilation Ventilazione Ventilación	sw/w	O						591 895	591 634	
	Belüftung vorglühen Diesel pre-heat	gn	X											Gebläse Blower	gn	X							589 780	592 172
	Dachventilator Roof ventilator Ventilateur plafonnier Ventilatore del tetto Ventilador de techo	gn	X									596 633		Gebläse Blower	hrt	X						593 060		
																	X					593 184		
																		X				593 337		
	Dreschwerkkühlung Cooling rotational speed	gn	X											Gebläse Blower Ventilation Ventilazione Ventilación	gn	X							592 174	596 195
	Entfroster Defroster Désembuage Sbrinatori Descongelador	gn	X									596 422		Gebläse Drehzahlverstellung Blower speed adjustment	gn			X					591 826	
																	X					593 279		
																		X				592 898		
	Frischluff Fresh air Air frais Aria fresca Aire fresco	gn	X									592 594		Gebläse Drehzahlverstellung Blower speed adjustment Réglage régime de ventilateur Regolazione giri ventilatore Regulación velocidad ventilador	gn			X					592 482	
																	hgn		X			592 482		
	Frontscheibe, Heizung u. Lüftung Windscreen Heating and ventilation Pare-brise, chauffage et aération Parabrezza. Riscaldamento e ventilazione. Parabrisas. Calefacción y ventilación	gb/w	X									594 465		Gebläse Drehzahlverstellung Blower speed adjustment Réglage de la vitesse de soufflerie Ventilaz. con cambio velocidad Cambio velocidad ventilador	gn	X							594 458	
																gn	X					592 022		

F = Rückseite bedruckt

O = Rückseite bedruckt mit Funktionsbeleuchtung

Einsätze (nicht für 533 . . .)

Inserts (not for 533 . . .)

Éléments (auf 533 . . .)

Piastrine (non per . . .)

Elementes (non vale . . .)



Symbol Symbol Symbole Simbolo Símbolo	Benennung Description Dénomination Denominazione Denominación	Farbe Color Couleur Colore Color	Symbollage Mounting Pos. demon. Montaggio Montaje				Bestell-Nr. Order No. No. de cde N. di ordine Referencia	Symbol Symbol Symbole Simbolo Símbolo	Benennung Description Dénomination Denominazione Denominación	Farbe Color Couleur Colore Color	Symbollage Mounting Pos. demon. Montaggio Montaje				Bestell-Nr. Order No. No. de cde N. di ordine Referencia
			normal	90° ↷	180° ↷	270° ↷					normal	90° ↷	180° ↷	270° ↷	
	Gebläse Drehzahlverstellung Blower speed adjustment	bl	X				589 695		Heizbarer Außenspiegel Exterior mirror defroster Degrivrage rétroviseur Specchietti retrovis. riscald. Retrovisor calentable	gb/sw	X			594 455	
		gn	X				595 127			gb/w	X			595 149	
							gn			X			X	594 451	
							sw/w			O				595 440	
	Gebläse langsam Blower slow	bl	X				589 696		Heizbarer Außenspiegel Exterior mirror defroster Degrivrage rétroviseur Specchietti retrovis. riscald. Retrovisor calentable		F			593 608	
		gb/sw	X				594 486			gn	X			592 684	
		gn	X				596 604							596 645	
		sw			X		596 388						X	596 646	
	Gebläse schnell Blower fast Ventilation forcée Ventilazione veloce Ventilación rápida	gb/w	X				595 108		Heizgebläse Warm air blower Ventilation air chaud Ventilazione riscaldamento Ventilador de calefacción				X	594 411	
		gn	X				596 642			gn		X		596 632	
		sw	X				596 612			sw	X			X	596 407
	Gebläseschw. Blower speed	hgn			X		591 824		Heizung Heating	gb	X			596 180	
	Gebläseverstellung Blower adjustment	gn	X				593 346		Heizung Heating Chauffage Riscaldamento Calefacción	gn	X			590 592	
		hgn	X				594 728			gn	X			596 622	
	Getriebeöltemperatur Transmission oil temperature	rt	X				589 520		Heizung Fahrersitz Heating driver's seat Chauffage siège du conducteur Riscaldamento sedile autista Calefacción asiento conductor	gn	X			595 141	
	Heckscheibenheizung Rear window heating Chauffage de la lunette arrière Lunotto con riscaldamento Calefacción del cristal trasero	gb/w	X				594 496		Heizung Fahrgastraum Heating passenger room Chauffage compartiment des passagers Riscaldamento cab. Passeggeri Calefacción cabina pasajeros		X			593 317	
		gn	X				594 462			gn		X		595 132	
		sw/w	O				591 626			sw/w	O			593 316	
	Heizbare Heckscheibe Rear window defroster Désembuage lunette AR Lunotto termico Cristal posterior calentable	gb/w		X			593 307		Heizung hinten Heating behind					595 606	
		gn	X				596 190			sw/w	F			589 534	
		rt	X				596 390								
	Heizbarer Außenspiegel Exterior mirror defroster Degrivrage rétroviseur Specchietti retrovis. riscald. Retrovisor calentable						596 172		Heizung vorn Heating front Chauffage à l'avant Riscaldamento anteriore Calefacción delantera	gn	X			595 142	
		gn	X				595 137			gn		X		593 318	

F = Rückseite bedruckt

O = Rückseite bedruckt mit Funktionsbeleuchtung

Einsätze (nicht für 533 . . .)

Inserts (not for 533 . . .)

Éléments (auf 533 . . .)

Piastrine (non per . . .)

Elementes (non vale . . .)



Symbol Symbol Symbole Simbolo Símbolo	Benennung Description Dénomination Denominazione Denominación	Farbe Color Couleur Colore Color	Symbollage Mounting Pos. demon. Montaggio Montaje				Bestell-Nr. Order No. No. de cde N. di ordine Referencia	Symbol Symbol Symbole Simbolo Símbolo	Benennung Description Dénomination Denominazione Denominación	Farbe Color Couleur Colore Color	Symbollage Mounting Pos. demon. Montaggio Montaje				Bestell-Nr. Order No. No. de cde N. di ordine Referencia			
			normal	90°	180°	270°					normal	90°	180°	270°				
	Innenraumheizung Heating	sw/w	F						Kühlschrank Refrigerator	sw/w	O						589 536	592 135
	Innenraumheizung Heating	gn	X						Kühltemperatur Cooling temperature	rt		X					590 828	594 420
	Klimaanlage Air-conditioning system	sw/w	O						Kühlung Cooling Refroidissement Refrigerazione Refrigeración	bl	X						589 486	595 159
	Klimaanlage Air-conditioning system	gn							Kühlung Cooling Refroidissement Refrigerazione Refrigeración	gn	X						589 486	596 101
ACS	Klimaanlage Air-conditioning system	rt	X						Lüftung aus Ventilation off	sw/w	F						590 080	589 538
AC	Klimaanlage Air-conditioning system	sw/w	F						Lüftungskanal Ventilation	sw/w	F						591 042	589 540
	Klimaanlage Air-conditioning system	bl/w			F				Lüftungskanal Ventilation Canalisation d'air Condotti di ventilazione Conducto de ventilación	gn	X						591 160	595 139
	Klimaanlage Air-conditioning system Chauffage pendant l'arrêt Riscaldamento posteggio Calefacción de estacionam.	sw/w	O						Lüftungsmotor Ventilator motor Moteur du ventilateur Motore di ventilazione Motor de ventilación	gn	X						592 119	595 138
	Klimaanlage Air-conditioning system	gn	X						Luftfilter Air cleaner	hgb		X					591 228	593 354
	Klimaanlage Air-conditioning system	w/sw	X						Luftfilter Air cleaner	hgb			X				592 407	593 351
	Kraftstoff vorwärmen Prewarm fuel Préchauffage carburant Preriscaldamento combustibile Precalentamiento combustible	gn	X						Luftfilter Air cleaner Filtre à air Filtro aria Filtro de aire	gb/sw	X						593 289	594 470
									Luftfilter Air cleaner Filtre à air Filtro aria Filtro de aire	gb/w	X							596 140
									Luftfilter Air cleaner Filtre à air Filtro aria Filtro de aire			X						595 192
									Luftfilter Air cleaner Filtre à air Filtro aria Filtro de aire	rt	X							594 423
									Luftfilter Air cleaner Filtre à air Filtro aria Filtro de aire				X					591 265

F = Rückseite bedruckt

O = Rückseite bedruckt mit Funktionsbeleuchtung

Einsätze (nicht für 533 . . .)

Inserts (not for 533 . . .)

Éléments (auf 533 . . .)

Piastrine (non per . . .)

Elementes (non vale . . .)



Symbol Symbol Symbole Simbolo Símbolo	Benennung Description Dénomination Denominazione Denominación	Farbe Color Couleur Colore Color	Symbollage Mounting Pos. demon. Montaggio Montaje				Bestell-Nr. Order No. No. de cde N. di ordine Referencia	Symbol Symbol Symbole Simbolo Símbolo	Benennung Description Dénomination Denominazione Denominación	Farbe Color Couleur Colore Color	Symbollage Mounting Pos. demon. Montaggio Montaje				Bestell-Nr. Order No. No. de cde N. di ordine Referencia											
			normal	90°	180°	270°					normal	90°	180°	270°												
	Motor vorwärmen Engine start	gb/sw	X						gn	X					590 800		Spiegelheizung Exterior rear view mirror heating	gn	X					591 581		
									hgn			X						hgn			X				591 765	
	Motorheizung Engine heating Chauffage moteur Riscaldamento motore Calefacción para el motor	gn	X						gn	X								gn			X				596 395	
												X									X				596 410	
	Motoröltemperatur Engine oil temperature	rt	X						sw/w				F					sw/w							590 068	
	Ölfiltertemperatur Temperature oil filter	hgb	X															rt	X						593 352	
				X																	X				593 349	
	Öltemperatur Temperature of oil	hrt	X						gn	X								gn			X				593 175	
				X																	X				593 331	
	Partikelfilter Particle filter	gb	X						sw/w									sw/w			O					592 094
	Seitliches Gebläse Side blower	gn	X						gn	X								gn			X					594 438
	Sitzheizung Seat heating Chauffage des sièges Riscaldamento sedili Calefacción del asiento	gb/w	X																							596 139
		gn	X						gn									gn			X					595 437
		sw/w	O						sw/w												O					592 370
	Sitzheizung Seat heating Chauffage des sièges Riscaldamento sedili Calefacción del asiento	gn	X						gn	X								gn			X					595 135
									sw									sw			X					594 702

F = Rückseite bedruckt

O = Rückseite bedruckt mit Funktionsbeleuchtung

Einsätze (nicht für 533 . . .)

Inserts (not for 533 . . .)

Éléments (auf 533 . . .)

Piastrine (non per . . .)

Elementes (non vale . . .)



Symbol Symbol Symbole Símbolo Símbolo	Benennung Description Dénomination Denominazione Denominación	Farbe Color Couleur Colore Color	Symbollage Mounting Pos. demon. Montaggio Montaje				Bestell-Nr. Order No. No. de cde N. di ordine Referencia	Symbol Symbol Symbole Símbolo Símbolo	Benennung Description Dénomination Denominazione Denominación	Farbe Color Couleur Colore Color	Symbollage Mounting Pos. demon. Montaggio Montaje				Bestell-Nr. Order No. No. de cde N. di ordine Referencia						
			normal	90° ↘	180° ↖	270° ↙					normal	90° ↘	180° ↖	270° ↙							
	Ventilator hinten Fan behind	sw/w	0				592 121														
	Ventilator (Decke) Fan (ceiling) Ventilateur (plafond) Ventilatore (soffitto) Ventilador (techo)	gn	X				595 140														
		sw/w	0					593 607													
	Vorglühen Pre-glowing	or/sw	X				589 502														
		sw/w	0					589 492													
						F			590 786												
	Vorglühen aus Pre-glowing off	sw/w	0				589 490														
	Vorwärmegerät / Vorglühen Preheating (glow plug) Préchauffage (bougie de réchauffage) Preriscaldam. ad incandescenza Precalentar (bujía incandesc.)	gb/w	X				596 120														
				X				596 402													
					X			594 796													
		gn				X		596 631													
		or			X			593 068													
		sw/w				F		592 770													
	Vorwärmen Preheating Préchauffage Preriscaldamento Precalentar	gb/sw	X				594 479														
		gb/w	X					596 117													
						X			594 742												
	Zusatzheizung Additional heating Chauffage complémentaire Riscaldamento supplementare Calefacción adicional	sw/w	0				593 597														
	Zusatzheizung Additional heating Chauffage complémentaire Riscaldamento supplementare Calefacción adicional	gn	X				596 121														

F = Rückseite bedruckt

0 = Rückseite bedruckt mit Funktionsbeleuchtung

Einsätze (nicht für 533 . . .)

Inserts (not for 533 . . .)

Éléments (auf 533 . . .)

Piastrine (non per . . .)

Elementes (non vale . . .)



Symbol Symbol Symbole Simbolo Símbolo	Benennung Description Dénomination Denominazione Denominación	Farbe Color Couleur Colore Color	Symbollage Mounting Pos. demon. Montaggio Montaje				Bestell-Nr. Order No. No. de cde N. di ordine Referencia	Symbol Symbol Symbole Simbolo Símbolo	Benennung Description Dénomination Denominazione Denominación	Farbe Color Couleur Colore Color	Symbollage Mounting Pos. demon. Montaggio Montaje				Bestell-Nr. Order No. No. de cde N. di ordine Referencia																																													
			normal	90° ↘	180° ↙	270° ↗					normal	90° ↘	180° ↙	270° ↗																																														
V. Antriebe Drives Transmissions Transmissioni Transmisiones														Achse heben/senken Axle lift/lower Montée-Descente essieu Asse Sollevato-Abassato Eje Levantar-Bajar	gb/w	X				593 415		X			588 789			X		589 679		X			589 922			X		589 283																				
	2 WD 2 WD select	sw/w	0				591 652		Achse senken Axle lower	sw/w	0					591 293		Achse senken Axle lower	rt			X			593 409		Achse senken Axle lower	gb/w	X			594 435		Achse senken Axle lower	gn		X		588 799		Achse senken Axle lower	gn		X		589 312														
	Abschalten 1. Achse Disengage 1st axle Mise hors marche du 1er essieu Disinserzione 1° asse Desacoplar 1° eje	rt	X				596 129		Achse senken Axle lower	or	X					596 159		Achse senken Axle lower	gb/w		X				592 671		Achse senken Axle lower	gb/w	X			594 355		Achse senken Axle lower	gb/w		X		594 747		Achse senken Axle lower	gn	X			594 712		Achse senken Axle lower	gn	X			592 858		Achse senken Axle lower	gn	X			593 043
	Achse Axle	or	X				596 159		Achse senken Axle lower	gn		X				592 671		Achse senken Axle lower	gb/w		X				594 355		Achse senken Axle lower	gn	X			594 712		Achse senken Axle lower	gn	X			592 858		Achse senken Axle lower	gn	X			593 043														
	Achse 2 heben/senken Axle 2 lift/lower	sw/w	0				591 295		Achse senken Axle lower	gn		X				592 671		Achse senken Axle lower	gb/w	X				594 355		Achse senken Axle lower	gn	X			594 712		Achse senken Axle lower	gn	X			592 858		Achse senken Axle lower	gn	X			593 043															
	Achse 3 heben/senken Axle 3er lift/lower Montée-Descente essieu 3 3° asse Sollevato-Abassato Eje 3, Levantar-Bajar	gb/w	X				593 400		Achse verstellen Axle adjustment	gb	X					589 891		Achse verstellen Axle adjustment	gn	X				590 206		Achse verstellen Axle adjustment	gn	X			592 206		Achse verstellen Axle adjustment	gn	X			590 206		Achse verstellen Axle adjustment	gn	X			590 206															
	Achse 3 + 4 heben Axle 3 + 4 lift Montée essieu 3 + 4 Asse 3 + 4 sollevato Eje 3 + 4 levantar	gb/w	X				592 575		Achse verstellen Axle adjustment	gn	X					592 768		Achse verstellen Axle adjustment	gn	X				592 768		Achse verstellen Axle adjustment	gn	X			592 768		Achse verstellen Axle adjustment	gn	X			592 768		Achse verstellen Axle adjustment	gn	X			592 768															
	Achse angehoben Axle lifted	gb	X				589 670		Achse verstellen Axle adjustment	gn	X					592 768		Achse verstellen Axle adjustment	gn	X				592 768		Achse verstellen Axle adjustment	gn	X			592 768		Achse verstellen Axle adjustment	gn	X			592 768		Achse verstellen Axle adjustment	gn	X			592 768															
	Achse heben Axle lift	gb	X				589 672		Achsen ausgleichen Axle load distribution Répartition de charge d'essieu Compenso assali Compensación de los ejes	rt	X					592 914		Achsen ausgleichen Axle load distribution Répartition de charge d'essieu Compenso assali Compensación de los ejes	rt	X				592 914		Achsen ausgleichen Axle load distribution Répartition de charge d'essieu Compenso assali Compensación de los ejes	rt	X			592 914		Achsen ausgleichen Axle load distribution Répartition de charge d'essieu Compenso assali Compensación de los ejes	rt	X			592 914		Achsen ausgleichen Axle load distribution Répartition de charge d'essieu Compenso assali Compensación de los ejes	rt	X			592 914															

F = Rückseite bedruckt

0 = Rückseite bedruckt mit Funktionsbeleuchtung

Einsätze (nicht für 533 . . .)

Inserts (not for 533 . . .)

Éléments (auf 533 . . .)

Piastrine (non per . . .)

Elementes (non vale . . .)



Symbol Symbol Symbole Simbolo Símbolo	Benennung Description Dénomination Denominazione Denominación	Farbe Color Couleur Colore Color	Symbollage Mounting Pos. demon. Montaggio Montaje				Bestell-Nr. Order No. No. de cde N. di ordine Referencia	Symbol Symbol Symbole Simbolo Símbolo	Benennung Description Dénomination Denominazione Denominación	Farbe Color Couleur Colore Color	Symbollage Mounting Pos. demon. Montaggio Montaje				Bestell-Nr. Order No. No. de cde N. di ordine Referencia				
			normal	90° ↘	180° ↙	270° ↻					normal	90° ↘	180° ↙	270° ↻					
	Achsenfederung 1 - 3 Axle suspension 1 - 3 Amortissement d'essieu 1 - 3 Sospensione assale 1 - 3 Suspensión del eje 1 - 3	gb/w	X					Anfahrhilfe Start support	gn			X			593 418	590 578			
	Achsverstellung 2 Axle adjustment of 2	gb	X					Anhänger Trailer -	gn		X				591 289	595 177			
	Allradantrieb All wheel drive 4 roues motrices Trazione integrale Tracción 4 ruedas	sw/w		F				APS auf/ab APS up/down	gn	X					592 774	588 022			
	Allradantrieb All wheel drive 4 roues motrices Trazione integrale Tracción 4 ruedas	gn	X					Ausgleich Achse 1,2,3 Axle 1,2,3 load distribution Répart. de charge d'essieu 1,2,3 Compenso assali 1,2,3 Compensación de los ejes 1,2,3	gn	X						596 470	592 880		
		sw	X															596 605	
	Allradantrieb All wheel drive 4 roues motrices Trazione integrale Tracción 4 ruedas	rt	X					Außenspiegel schwenken Exterior mirror Rétroviseur Specchietto retrovisore Retrovisor	sw/w		0					592 519	591 809		
	Allradantrieb All wheel drive	gb/w	X					Bergfahrt Steep slope	gn		X						591 336	590 612	
			X																596 183
		gn		X															589 937
					X														595 427
		or	X																591 508
			X			593 057					X				592 902				
	Allradantrieb All wheel drive 4 roues motrices Trazione integrale Tracción 4 ruedas	gn			X			Beschl. Leerdrehzahl Increased empty rotational speed	sw/w		0					596 802	592 127		
	Allradantrieb unterbrochen All-wheel drive interrupted -	gn		X				Bremsantrieb Brake gear -	gn	X									
						X													
	Allradantrieb (6 WD) All wheel drive (6 WD) 6 roues motrices (6 WD) Trazione integrale Tracción 6 ruedas (6 WD)	gn	X					Bremse 1 zentriert Fixing brake 1	rt	X						596 201	589 530		

F = Rückseite bedruckt

0 = Rückseite bedruckt mit Funktionsbeleuchtung

Einsätze (nicht für 533 . . .)

Inserts (not for 533 . . .)

Éléments (auf 533 . . .)

Piastrine (non per . . .)

Elementes (non vale . . .)



Symbol Symbol Symbole Simbolo Símbolo	Benennung Description Dénomination Denominazione Denominación	Farbe Color Couleur Colore Color	Symbollage Mounting Pos. demon. Montaggio Montaje				Bestell-Nr. Order No. No. de cde N. di ordine Referencia	Symbol Symbol Symbole Simbolo Símbolo	Benennung Description Dénomination Denominazione Denominación	Farbe Color Couleur Colore Color	Symbollage Mounting Pos. demon. Montaggio Montaje				Bestell-Nr. Order No. No. de cde N. di ordine Referencia				
			normal	90° ↷	180° ↷	270° ↷					normal	90° ↷	180° ↷	270° ↷					
	Bremse 2 zentriert Fixing brake 2	rt	X						Differentialsperre 4. Achse Differential lock 4th axle Verr. du différentiel 4ème essieu Blocco diff. 4° asse Bloquero diferencial 4° eje	gn	X					589 528	596 218		
	Bremse 3 zentriert Fixing brake 3	rt	X						Differentialsperre HA quer Differential lock HA, transversal	rt	X					589 526	591 692		
	Dachluke hinten Sliding roof rear	sw/w	O						Differentialsperre hinten Differential lock rear	sw/w	O					592 139	590 568		
	Dachluke vorne Sliding roof front	sw/w	O						Differentialsperre hinten Differential lock rear Verrouillage du différentiel AR Blocco diff. Posteriore Bloqueo diferencial trasero	gn	X					592 141	596 199		
	Differentialsperre Differential lock Verrouillage du différentiel Blocco differenziale Bloqueo diferencial	gb/sw	X						Differentialsperre hinten Differential lock rear Verrouillage du différentiel AR Blocco diff. Posteriore Bloqueo diferencial trasero	gb/w	X					594 473	592 593		
		gb/w	X							gn	X					596 116	596 164		
gn	X						rt			X					596 220	596 405			
or	X						sw			X					594 409	594 409			
sw	X														596 378	596 378			
	Differentialsperre Differential lock Verrouillage du différentiel Blocco differenziale Bloqueo diferencial	gb/w	X						Differentialsperre hinten u. mitte Differential lock rear and middle	rt	X					592 856	588 856		
				X												592 411			
		gn	X													594 426			
				X												596 181			
			X													593 625			
				X												593 065			
					X											595 413			
						X										592 766			
	Differentialsperre längs Differential lock longitudinal	sw		X					Differentialsperre längs Differential lock longitudinal	rt	X					592 716	588 502		
		sw/w			X											593 633			
	Differentialsperre Differential lock Verrouillage du différentiel Blocco differenziale Bloqueo diferencial	sw/w	F						Differentialsperre längs Differential lock longitudinal Verr. du différentiel longitudinal Blocco diff. longitudinale* Bloqueo diferencial longitudinal	gn			X			592 773	596 420		
				O												592 690			
		gb/w	X									gn	X					594 794	596 219
		gn	X															596 623	
	Differentialsperre 1. Hinterachse quer Differential lock 1th axle diagonal	rt	X						Differentialsperre quer Differential lock transversal Verr. du différentiel transversal Blocco diff. trasversale* Bloqueo diferencial transversal	gn			X			594 777	596 166		
		sw/w	O													592 369	596 791		

F = Rückseite bedruckt

O = Rückseite bedruckt mit Funktionsbeleuchtung

Einsätze (nicht für 533 . . .)

Inserts (not for 533 . . .)

Éléments (auf 533 . . .)

Piastrine (non per . . .)

Elementes (non vale . . .)



Symbol Symbol Symbole Simbolo Símbolo	Benennung Description Dénomination Denominazione Denominación	Farbe Color Couleur Colore Color	Symbollage Mounting Pos. demon. Montaggio Montaje				Bestell-Nr. Order No. No. de cde N. di ordine Referencia	Symbol Symbol Symbole Simbolo Símbolo	Benennung Description Dénomination Denominazione Denominación	Farbe Color Couleur Colore Color	Symbollage Mounting Pos. demon. Montaggio Montaje				Bestell-Nr. Order No. No. de cde N. di ordine Referencia																					
			normal	90°	180°	270°					normal	90°	180°	270°																						
	Differentialsperre vorn Differential lock front Verr. du différentiel avant Blocco diff. Anteriore Bloqueo diferencial, delantero	gn	X						Fahrschwingdämpfer Slewing damper Compensateur d'inclin. latérale Ammortizzatore d'inclin. laterale Amortiguador de oscilación	rt	X						596 200		593 618																	
	Differentialsperre vorn Differential lock front Verr. du différentiel avant Blocco diff. Anteriore Bloqueo diferencial, delantero	gb/w	X						Federung Springing	gb/w		X					593 310		588 790																	
				X										X				594 483		589 681																
		gn			X									X						596 803		589 284														
			rt	X																594 410																
	Doppelachse Double axle	rt	X						Feldfahrt Field drive	hrt		X					592 601		593 339																	
																			X		593 186															
																				X																592 478
																					X															
	Doppelachse vorne Double axle front	gn	X						Freigabe Dreschtrommel	gn	X								589 911	587267																
	Doppelachse vorne Double axle front	gn	X						Geschwindigkeit hinten Rear speed	sw/or				F					589 913	591 359																
	Druckluftfederung Pneumatic suspension Amortissement pneumatique Suspensione ad aria Suspensión neumática	gb/w			X				Getriebe Transmission	sw/or											593 444															
			sw/w			F																											591 515	589 066		
	Einstellung Schnitthöhe Concave adjustment	gn	X						Hänger kippen Trailer tilt	hgn				X							591 078	592 472														
	Entriegeln Zwischenstellung One axle locked Déblocage 2e essieu directeur Bloccaggio intermedio Desbloqueo 2 eje conductor	rt				X			Hangausgleich Slope compensation Compensateur de niveau Conguaglio pendio Estabilizador terreno inclinado	gn	X										593 045	593 280														
	Fahrerkabine heben/senken Cab raise/lower	gn	X							gn	X										590 610															
													X																592 903							
										hgb	X																			593 350						
												X																			593 353					

F = Rückseite bedruckt

O = Rückseite bedruckt mit Funktionsbeleuchtung

Einsätze (nicht für 533 . . .)

Inserts (not for 533 . . .)

Éléments (auf 533 . . .)

Piastrine (non per . . .)

Elementes (non vale . . .)



Symbol Symbol Symbole Simbolo Símbolo	Benennung Description Dénomination Denominazione Denominación	Farbe Color Couleur Colore Color	Symbollage Mounting Pos. demon. Montaggio Montaje				Bestell-Nr. Order No. No. de cde N. di ordine Referencia	Symbol Symbol Symbole Simbolo Símbolo	Benennung Description Dénomination Denominazione Denominación	Farbe Color Couleur Colore Color	Symbollage Mounting Pos. demon. Montaggio Montaje				Bestell-Nr. Order No. No. de cde N. di ordine Referencia													
			normal	90° ↘	180° ↙	270° ↻					normal	90° ↘	180° ↙	270° ↻														
	Hauptkupplung Main clutch	hrt			X				Hinterachse senken Rear axle lower	sw/w		0							591 297									
	Header leveling Header leveling	gn				X			Hintere Luftfederung Rear air	sw/w		0							591 847									
	Heben Raise	gn	X						Höhenregelung Hight regulation	gn		X							594 431									
	Heben Raise Lever Sollevamento Subir	gn	X						Kabine nach vorne Cab forwards	gn		X							595 423									
	Heben - Senken Raise - Lower Lever - Descendre Sollevamento - Abbassare Subir - Bajar	gn	X						Keilriemen Drive belt	rt		X							594 405									
		or	X																	592 901								
		sw/w	0																		591 658							
	Hinterachse Rear axle Essieu AR Ponte posteriore Eje trasero	rt	X						Kneeling Kneeling	or/sw		X							593 406									
										sw/w		0														589 510		
	Hinterachse auf/ab Rear axle up/down	gb	X						Kneeling absenken Kneeling lower	gb		X							592 553									
										or		X														589 240		
										or/sw		X															594 762	
										sw		X																589 278
										sw/w		F																594 415
	Hinterachse auf/ab Rear axle up/down	gb	X						Längsdifferentialsperre Longitudinal differential lock Verr. différentiel longitudinal Blocco diff. Longitudinale Bloqueo diferencial longitudinal	rt		X							591 602									
										sw/w		0														591 691		
	Hinterachse entriegeln Rear axle unlock Déblocage essieu AR Sbloccaggio ponte posteriore Desenclavar eje trasero	gn	X						Längsdifferentialsperre Longitudinal differential lock Verr. différentiel longitudinal Blocco diff. Longitudinale Bloqueo diferencial longitudinal	sw/w		0							591 994									
		rt	X																	592 487								

F = Rückseite bedruckt

0 = Rückseite bedruckt mit Funktionsbeleuchtung

Einsätze (nicht für 533 . . .)

Inserts (not for 533 . . .)

Éléments (auf 533 . . .)

Piastrine (non per . . .)

Elementes (non vale . . .)



Symbol Symbol Symbole Simbolo Símbolo	Benennung Description Dénomination Denominazione Denominación	Farbe Color Couleur Colore Color	Symbollage Mounting Pos. demon. Montaggio Montaje				Bestell-Nr. Order No. No. de cde N. di ordine Referencia	Symbol Symbol Symbole Simbolo Símbolo	Benennung Description Dénomination Denominazione Denominación	Farbe Color Couleur Colore Color	Symbollage Mounting Pos. demon. Montaggio Montaje				Bestell-Nr. Order No. No. de cde N. di ordine Referencia
			normal	90° ↘	180° ↙	270° ↗					normal	90° ↘	180° ↙	270° ↗	
	Längsdifferentialsperre Longitudinal differential lock	rt	X					Nebenantrieb Auxiliary drive	rt	X				591 686	
									w/sw	X				590 825	
	Längsdifferentialsperre Longitudinal differential lock Verr. différentiel longitudinal Blocco diff. Longitudinale Bloqueo diferencial longitudinal	gb/sw	X					Nebenantrieb Auxiliary drive	rt	X				592 030	
		gb/w	X											596 111	
	Längsdifferentialsperre Longitudinal differential lock Verr. différentiel longitudinal Blocco diff. Longitudinale Bloqueo diferencial longitudinal	gb/w	X					Nebenantrieb Auxiliary drive Commande latérale Trasmissione laterale Tracción lateral	gb/w		X			591 155	
		gn	X									X		595 185	
		sw	X						gn	X				596 624	
									rt	X			X	592 026	
														596 413	
	Längssperre 1.-2. Achse Longitudinal lock, 1st-2nd axle Verr. longitud. 1er-2ème essieu Blocco longitud. 1°-2° asse Bloqueo longitudinal, 1°-2° eje	gn	X					Nebenantrieb 2 Auxiliary drive 2	rt	X				591 684	
	Lageregelung Position regulation	gn	X					Niveau absenken Level lower	rt	X				591 678	
				X										590 611	
					X									592 904	
		rt	X											590 609	
					X									592 899	
	Lenkung Hinterachse Steering rear axle	rt	X					Niveau heben Level lift	gb/w	X				595 161	
									gn	X				590 244	
	Mähdrescher hinten Combine back	sw/or				F		Niveau heben Level lift	rt	X				594 778	
	Mähdrescher vorne Combine front	sw/or				F		Niveau regeln Level control Régulation de niveau Regolazione livello Regulación del nivel	gn	X				593 412	
	Motordrehzahlbremse Engine speed brake	sw/w	O					Niveau regeln Level control Régulation de niveau Livellamento Regulación de nivel	gb/w	X				593 624	

F = Rückseite bedruckt

O = Rückseite bedruckt mit Funktionsbeleuchtung

Einsätze (nicht für 533 . . .)

Inserts (not for 533 . . .)

Éléments (auf 533 . . .)

Piastrine (non per . . .)

Elementes (non vale . . .)



Symbol Symbol Symbole Simbolo Símbolo	Benennung Description Dénomination Denominazione Denominación	Farbe Color Couleur Colore Color	Symbollage Mounting Pos. demon. Montaggio Montaje				Bestell-Nr. Order No. No. de cde N. di ordine Referencia	Symbol Symbol Symbole Simbolo Símbolo	Benennung Description Dénomination Denominazione Denominación	Farbe Color Couleur Colore Color	Symbollage Mounting Pos. demon. Montaggio Montaje				Bestell-Nr. Order No. No. de cde N. di ordine Referencia			
			normal	90° ↘	180° ↙	270° ↻					normal	90° ↘	180° ↙	270° ↻				
	Niveau regeln Level control Réglage du niveau Regolazione livello Regulación del nivel	rt	X						Pendelachse A Cross-shaft axle A	rt	X					595 430		589 796
	Niveauregelung Bus Level adjustable bus	sw/w	F						Pendelachse entriegeln Cross-shaft axle unlock	rt	X					589 452		589 792
	Niveauregelung hinten Level adjustable back	sw/w	O						Pendelachse sperren Cross-shaft axle locked	rt	X					592 143		589 794
							591 439											
	Niveauregelung vorne Level adjustable front	sw/w	O						Pendelachsenarretierung Cross-shaft axle lock Bloc. essieu pendulaire Serratura assale ascillante Cierre eje oscilante	or	X					592 145		594 491
							591 441											
	Niveauregulierung Level adjustable	gn	X						Pendelachsschloß Cross-shaft axle lock Bloc. essieu pendulaire Serratura assale oscillante Cierre eje oscilante	gb/sw	X					594 429		594 477
							gb/w			X					595 435			
							sw/w					F				592 689		
	Niveauregulierung Level adjustable	gb/sw	X						Pendelachsschloß AUS Cross-shaft axle lock OFF Bloc. essieu pendulaire ouvert Serrat. ass. oscill. Disinsertio Cierre eje oscilante abierto	rt	X					591 681		595 147
	Normalniveau Normal level Niveau normal Livello normale Nivel normal	gn	X						Planierschild höhenverst. Header - lateral adjustable for height	hgn						594 407		591 822
				X			589 944											
			sw/w	F			589 453											
	Pendelachse Cross-shaft axle	rt	X						Planierschild rechts neigen Header - lateral tilt right	sw/w			F			590 304		591 621
	Pendelachse Cross-shaft axle Essieu pendulaire Assale oscillate Eje oscilante	or	X						Planierschild rechts neigen Header - lateral tilt right	hgn					596 158		589 860	
			X				592 917											
		rt			X					594 753	hrt			X		591 757		

F = Rückseite bedruckt

O = Rückseite bedruckt mit Funktionsbeleuchtung

Einsätze (nicht für 533 . . .)

Inserts (not for 533 . . .)

Éléments (auf 533 . . .)

Piastrine (non per . . .)

Elementes (non vale . . .)



Symbol Symbol Symbole Simbolo Símbolo	Benennung Description Dénomination Denominazione Denominación	Farbe Color Couleur Colore Color	Symbollage Mounting Pos. demon. Montaggio Montaje				Bestell-Nr. Order No. No. de cde N. di ordine Referencia	Symbol Symbol Symbole Simbolo Símbolo	Benennung Description Dénomination Denominazione Denominación	Farbe Color Couleur Colore Color	Symbollage Mounting Pos. demon. Montaggio Montaje				Bestell-Nr. Order No. No. de cde N. di ordine Referencia							
			normal	90° ↘	180° ↙	270° ↗					normal	90° ↘	180° ↙	270° ↗								
	Quersperre 1. Achse Transversal lock, 1st axle Verr. transversal 1er essieu Blocco trasversale 1° asse Bloqueo transversal, 1° eje	gn	X						Schwerpunkt Center of gravity Centre de gravité Punto di rotazione Centro de gravedad	gb/w	X					596 130					593 421	
	Quersperre 2.-3. Achse Transversal lock, 2nd-3rd axle Verr. transv. 2ème-3ème essieu Blocco trav. 2°-3° asse Bloqueo transversal, 2°-3° eje	gn	X						Senken Lower -	gn	X						596 131				594 432	
	Retarder Abschaltung Retarder switch off	sw/w	O						Senken Lower Descendre Abbassare Bajar	gn	X						592 125				595 422	
	Ruder hoch Lift rockshaft -	sw/w		F					Stellung rechts Position right side -	gn				X			592 769				594 784	
	Schiebedach Sliding roof	sw/w	O						Straßenfahrt Drive on road	gn		X					591 258				593 344	
										hgn		X					594 726					
	Schleppachse Trailing axle Essieu non propulsif Assale portante Eje arrastrado	gn							Vorderachse heben - senken Front axle lift/lower -	gb/w	X					X	596 396					
																X	591 079					
																X	596 412					
																X	592 859					
																X	594 776					
																X	594 748					
sw/w	O	591 291																				
	Schleppachse hinten hoch Lift rear trail axle -	gb/w	X						Vorderachse heben - senken Front axle lift/lower	gb	X						594 443				592 552	
	Schlupfregelung Slip regulation	gn	X						Vorderachse heben - senken Front axle lift/lower	gb	X						587696				592 603	
	Schwenkbremse Anti-slewing brake Frein flottant Freno antirollio Freno antiflotante	rt	X						Vorderachsenantrieb Front axle drive -	gn				X			592 850				594 786	

F = Rückseite bedruckt

O = Rückseite bedruckt mit Funktionsbeleuchtung

Einsätze (nicht für 533 . . .)

Inserts (not for 533 . . .)

Éléments (auf 533 . . .)

Piastrine (non per . . .)

Elementes (non vale . . .)



Symbol Symbol Symbole Simbolo Símbolo	Benennung Description Dénomination Denominazione Denominación	Farbe Color Couleur Colore Color	Symbollage Mounting Pos. demon. Montaggio Montaje				Bestell-Nr. Order No. No. de cde N. di ordine Referencia	Symbol Symbol Symbole Simbolo Símbolo	Benennung Description Dénomination Denominazione Denominación	Farbe Color Couleur Colore Color	Symbollage Mounting Pos. demon. Montaggio Montaje				Bestell-Nr. Order No. No. de cde N. di ordine Referencia						
			normal	90° ↷	180° ↷	270° ↷					normal	90° ↷	180° ↷	270° ↷							
	Vorderer Teil umkehren The front part to turn back	gb	X						Zapfwelle linkslauf Tap shaft lefthanded rotation	or	X					587772					594 740
	Vorderradantrieb Front wheel drive Entrainement frontal Trazione anteriore Tracción delantera	gb			X				Zapfwelle rechtslauf Stufe 1, 2 Tap shaft righthanded rotation stage 1,2	gn	X					596 163					594 735
	Vorder- und Hinterachse Front axle and rear axle Essieu AV - Essieux AV et AR Asse anteriore - Asse ant. e post. Eje delantero - Eje delantero y trasero	gn	X					FRONT PTO	Zapfwelle vorn Tap shaft, front Prise de force, AV Presa di forza, anteriore Toma de fuerza, delantero	gn			X			594 406					593 640
	Wechsel Anhänger Change trailer	gn			X				Zapfwelle, langsam Tap shaft, slow Prise de force, lentement Presa di forza, lenta Toma de fuerza, lento	gb/w		X				595 175					592 317
										or	X			X				592 882			
	Zapfwelle Tap shaft	gn			X				Zapfwelle, schnell Tap shaft, fast Prise de force, forcée Presa di forza, veloce Toma de fuerza, rápido	gb/w		X				590 310					592 318
										or	X			X				592 881			
	Zapfwelle Tap shaft Prise de force Presa di forza Toma de fuerza	drt	X						Zuschalten 2. Achse Engage 2nd axle Conjonction 2ème essieu Collegamento 2° asse Acoplar 2° eje	gn	X					594 402					596 133
		gb	X				589 847														
		gn	X				596 392														
		or		X			593 066														
		sw	X				596 616														
		sw/w	O				591 260														
	X				592 775																
	Zapfwelle Allradantrieb Tap shaft all-wheel drive	gn	X						Zuschalten VA-Allrad Engage VA all wheel	rt	X					594 424					591 687
AUTO 	Zapfwelle autom. Tap shaft autom.	gn			X				Zwischenstellung an Intermediate position on	gb/w				X		589 282					592 857
										gn				X		594 785					
	Zapfwelle bremsen Tap shaft braking	gb	X													591 016					
		or		X												593 071					
		sw/w		F												592 777					

F = Rückseite bedruckt

O = Rückseite bedruckt mit Funktionsbeleuchtung

Einsätze (nicht für 533 . . .)

Inserts (not for 533 . . .)

Éléments (auf 533 . . .)

Piastrine (non per . . .)

Elementes (non vale . . .)



Symbol Symbol Symbole Simbolo Símbolo	Benennung Description Dénomination Denominazione Denominación	Farbe Color Couleur Colore Color	Symbollage Mounting Pos. demon. Montaggio Montaje				Bestell-Nr. Order No. No. de cde N. di ordine Referencia	Symbol Symbol Symbole Simbolo Símbolo	Benennung Description Dénomination Denominazione Denominación	Farbe Color Couleur Colore Color	Symbollage Mounting Pos. demon. Montaggio Montaje				Bestell-Nr. Order No. No. de cde N. di ordine Referencia								
			normal	90° ↘	180° ↙	270° ↻					normal	90° ↘	180° ↙	270° ↻									
VI. Motor / Getriebe																							
	Funktionsst. Getriebe Malfunction of gear	rt								X							589 514						
	Funktionsst. Motor Malfunction of engine	rt								X							589 516						
	Gang 1 Gear 1 -	rt				X				X							594 481						
	Gang 2 Gear 2 -	rt				X				X							594 482						
	Gang automatisch Gear automatic -	gn				X				X							596 182						
	Arbeitsdrehzahl Working speed Vitesse de travail Velocità di lavoro Velocidad de trabajo	gn	X							X							596 198						
	Automatisch abzählen automatic counted	w	X							X							587455						
	Gangschaltheilfe Gear selector Sélecteur de vitesse Selettore marce Selector de marcha	gn				X				X							587512						
	CNG - Motor Combined engine	gb	X										X				590 048						
	Gang langsam runter Gear slowly up -	gn								X							592 522						
	Gangposition halten Gear position hold	gn							X								589 521						
		hgn							X								594 774						
		w							X				X				594 773						
										X							594 729						
											X						589 068						
	Gangschaltung 1-2 Gear switsching 1-2	gn											X				587518						

F = Rückseite bedruckt

0 = Rückseite bedruckt mit Funktionsbeleuchtung

Einsätze (nicht für 533 . . .)

Inserts (not for 533 . . .)

Éléments (auf 533 . . .)

Piastrine (non per . . .)

Elementes (non vale . . .)



Symbol Symbol Symbole Simbolo Símbolo	Benennung Description Dénomination Denominazione Denominación	Farbe Color Couleur Colore Color	Symbollage Mounting Pos. demon. Montaggio Montaje				Bestell-Nr. Order No. No. de cde N. di ordine Referencia	Symbol Symbol Symbole Simbolo Símbolo	Benennung Description Dénomination Denominazione Denominación	Farbe Color Couleur Colore Color	Symbollage Mounting Pos. demon. Montaggio Montaje				Bestell-Nr. Order No. No. de cde N. di ordine Referencia
			normal	90° ↘	180° ↙	270° ↻					normal	90° ↘	180° ↙	270° ↻	
	Gangschaltung 3/N Gear switsching 3-N	gn			X				Leerlaufautomatik Idle - automatic Automatique de marche à vide Folle-automatico Marcha en vacío - automático	rt	X				596 162
	Gangwahlhilfe 1 Gear selector 1 Sélecteur de vitesse 1 Selettore marce 1 Selector de marcha 1	gn	X						Motor Engine	gn	X				588 849
	Geländegang All-terrain gear	gn	X						Motor Engine	gn		X			591 320
	Getriebe AUS Out of gear Transmission ARRET Transmissione disinserito Engranaje desacoplado	sw/w	O						Motor check Engine check	gb	X				591 803
	Getriebe AUS Out of gear Transmission ARRET Transmissione disinserito Engranaje desacoplado	gb/sw	X						Motor EDC Engine EDC	rt	X				591 801
		gb/w	X												
		gn			X										
		rt	X												
	Kontrolle Motordrehzahl Control engine speed	rt	X						Motor einblasen Engine blowing	rt	X				589 523
	Kupplung Clutch	gn	X						Motor max. Engine max.	gn	X				591 605
IDLE INC/DEC	Leerlauf Idle inc / dec	sw/w	O						Motor START Engine START Moteur START Motore START Motor START	gn	X				593 445
										sw	X				589 829
AEC	Leerlaufautomatik Idle - automatic Ralenti automatique Controllo autom. marcia a vuoto Regulador de marcha en vacío	gn	X						Motor STOP Engine STOP Moteur STOP Motore fermo Motor parado	gn			X		595 103
										rt	X				595 429

F = Rückseite bedruckt

O = Rückseite bedruckt mit Funktionsbeleuchtung

Einsätze (nicht für 533 . . .)

Inserts (not for 533 . . .)

Éléments (auf 533 . . .)

Piastrine (non per . . .)

Elementes (non vale . . .)



Symbol Symbol Symbole Símbolo	Benennung Description Dénomination Denominazione Denominación	Farbe Color Couleur Colore Color	Symbollage Mounting Pos. demon. Montaggio Montaje				Bestell-Nr. Order No. No. de cde N. di ordine Referencia	Symbol Symbol Symbole Símbolo	Benennung Description Dénomination Denominazione Denominación	Farbe Color Couleur Colore Color	Symbollage Mounting Pos. demon. Montaggio Montaje				Bestell-Nr. Order No. No. de cde N. di ordine Referencia
			normal	90° ↷	180° ↷	270° ↷					normal	90° ↷	180° ↷	270° ↷	
	Motor STOP Engine STOP Moteur STOP Motore fermo Motor parado	gn	X				595 434		Rückwärtsgang Reverse gear -	gn			X		594 756
		rt			X		595 152								
	Motor überhitzt Engine overheated Moteur surchauffé Motore sovrarisaldato Motor recalentado	rt	X				595 436	R	Rückwärtsgang Reverse gear	dgn	X				590 948
										gn	X				595 163
													X		
										or	X				594 766
	Motorabtrieb Engine do not shift	gb/sw	X				590 052		Rückwärtsgang Freigabe Reverse gear release Déblocage de la marche arrière Sbloccaggio retromarcia Desbloqueo de marcha atrás	gn	X				595 853
	Motorkontrolle Engine control	gn			X		589 950		Rückwärtsgang halten Reverse gear keep -	w	X				593 639
	Motorprüfung Engine check	gb	X				592 004	START	Start Start	gn	X				590 095
										rt			X		593 044
										w	X				594 418
	Motorstop automatisch Engine stop automatic	rt	X				591 197	I	Stufe 1 Grade 1 -	gn	X				592 855
	Motorstufe 5 Engine grade 5	bl	X				591 713	II	Stufe 2 Grade 2 -	gn	X				592 854
	Motorwelle Engine shaft	gn	X				588 434	III	Stufe 3 Grade 3	gn		X			589 798
													X		591 799
	Neutralstellung Neutral	gb/sw	X				591 682		Stufe F5 Grade 5	sw/w			X		592 697

F = Rückseite bedruckt

O = Rückseite bedruckt mit Funktionsbeleuchtung

Einsätze (nicht für 533 . . .)



Inserts (not for 533 . . .)

Éléments (auf 533 . . .)

Piastrine (non per . . .)

Elementes (non vale . . .)



Symbol Symbol Symbole Símbolo Símbolo	Benennung Description Dénomination Denominazione Denominación	Farbe Color Couleur Colore Color	Symbollage Mounting Pos. demon. Montaggio Montaje				Bestell-Nr. Order No. No. de cde N. di ordine Referencia	Symbol Symbol Symbole Símbolo Símbolo	Benennung Description Dénomination Denominazione Denominación	Farbe Color Couleur Colore Color	Symbollage Mounting Pos. demon. Montaggio Montaje				Bestell-Nr. Order No. No. de cde N. di ordine Referencia					
			normal	90° ↷	180° ↷	270° ↷					normal	90° ↷	180° ↷	270° ↷						
123	Stufenschaltung Stage switching -	gn		X																
TEST 	Test Getriebe Test gear Test de la transmission Prova trasmissione Test transmisión	gn	X																	
	Verbrennungsmotor Engine	sw/or	F																	
+ 	Verbrennungsmotor Engine	gn	X																	
F/R	Vorwärts-/Rückwärtsgang Forward Gear / Reverse Gear	gn	X																	

F = Rückseite bedruckt

0 = Rückseite bedruckt mit Funktionsbeleuchtung

Einsätze (nicht für 533 . . .)

Inserts (not for 533 . . .)

Éléments (auf 533 . . .)

Piastrine (non per . . .)

Elementes (non vale . . .)



Symbol Symbol Symbole Simbolo Símbolo	Benennung Description Dénomination Denominazione Denominación	Farbe Color Couleur Colore Color	Symbollage Mounting Pos. demon. Montaggio Montaje				Bestell-Nr. Order No. No. de cde N. di ordine Referencia	Symbol Symbol Symbole Simbolo Símbolo	Benennung Description Dénomination Denominazione Denominación	Farbe Color Couleur Colore Color	Symbollage Mounting Pos. demon. Montaggio Montaje				Bestell-Nr. Order No. No. de cde N. di ordine Referencia								
			normal	90° ↘	180° ↙	270° ↻					normal	90° ↘	180° ↙	270° ↻									
VII. Bremse																							
								Bremsdruck Brake pressure	hrt		X					593 187							
												X				593 340							
	Abgasbremse Exhaust brake Ralentisseur sur échappement Freno gas di scarico Freno por gas de escape	gn	X													594 761							
		sw	X						Bremsen lösen Release brakes Desserrage des freins Sbloccaggio freni Soltar frenos	rt	X					594 499							
ABS CROSS	ABS ABS	gb	X						Dauerbremse Retarder Freins à régime continu Freno permanente Freno permanente	gn	X					596 391							
		sw	X							sw	X					596 602							
	ABS aus ASR switch-off	gn	X						Dauerbremse Störung Retarder fault Dérangement frein parmanent Anomalia freno motore Fallo freno permanente	rt			X			594 754							
ABS GELÄNDE	ABS -Gelände ABS cross-country	gn	X						El. Bremsanlage Electric brake system Dispositif de freinage électrique Impianto frenante elettrico Sistema de freno eléctrico	gn	X					595 419							
	Anhänger ohne ABS Trailer without ABS Remorque sans ABS Rimorchio senza ABS Remolque sin ABS	gb/sw	X						Haltestellen Bremse Stop brake Freins de parking Freno di parcheggio Freno de parada	rt	X					595 111							
		gb/w	X									X				595 183							
	autom. Motorbremse Engine break	gb	X						Haltestellenbremse aus Stop brake off	sw/w	F					589 348							
	Bremsanlage Braking system	gn	X						Handbremse Hand brake	hrt	X					593 179							
												X				593 332							
	Bremsbelagkontrolle Brake lining check Contrôle de garniture des freins Controllo guarnizioni freni Control guarnición des frenos	rt			X				Motorbremse Engine brake Frein moteur Freno motore Freno de motor	gn	X					594 440							
		sw		X						sw/w	O					591 376							

F = Rückseite bedruckt

O = Rückseite bedruckt mit Funktionsbeleuchtung

Einsätze (nicht für 533 . . .)

Inserts (not for 533 . . .)

Éléments (auf 533 . . .)

Piastrine (non per . . .)

Elementes (non vale . . .)



Symbol Symbol Symbole Simbolo Símbolo	Benennung Description Dénomination Denominazione Denominación	Farbe Color Couleur Colore Color	Symbollage Mounting Pos. demon. Montaggio Montaje				Bestell-Nr. Order No. No. de cde N. di ordine Referencia	Symbol Symbol Symbole Simbolo Símbolo	Benennung Description Dénomination Denominazione Denominación	Farbe Color Couleur Colore Color	Symbollage Mounting Pos. demon. Montaggio Montaje				Bestell-Nr. Order No. No. de cde N. di ordine Referencia					
			normal	90° ↷	180° ↷	270° ↷					normal	90° ↷	180° ↷	270° ↷						
	Motorbremse Engine brake Frein moteur Freno motore Freno de motor	gb/w	X						Test ABS Test ABS	sw/w	O					593 676		592 153		
	Motorbremse 1, 2 Engine brake grade 1,2	sw/w	O						Test ABS-Anlage Test ABS unit Test système ABS Prova ABS Test, sistema ABS	rt	X					591 299		593 301		
	Motorbremse 1, 2, 3 Engine brake grade 1,2,3	sw/w	O						Verzögerungsbremse Deceleration brake Frein de ralentissement Freno di decelerazione Freno de deceleración	gn	X					591 374		596 338		
	Parkbremse Parking brake Frein stationnement Freno di stazionamento Freno estacionamiento	drt	X						Zusatzbremse Auxiliary brake Frein auxiliaire Freno ausiliario Freno auxiliar	gn	X					594 648		592 592		
		gn	X			X										596 309		595 164		
																	589 916			
		rt	X											X			596 173		592 031	
																X		595 193		
																	F	594 752		
				sw/or						F								591 369		
		w/rt	F											589 931						
	Parkbremse aus Parking brake off	rt	X													591 315				
	Retarderbremse Retarder brake	gb/sw	X													590 246				
		or/sw	X													589 511				
		sw/w	O													589 496				
	Sicherheitsbremse Safety brake	gb/sw	X													591 575				
	Störung ABS Anhänger Fault, Trailer ABS	or/sw	X													589 694				
		rt	X													593 295				
							X									593 296				
	Störung der Bremsanlage Brake system trouble Panne du dispositif de freinage Avaria impianto frenante Avería del sistema de frenos	gn	X													595 148				
		rt	X													596 144				
						X										595 194				
		sw/w	O													589 500				

F = Rückseite bedruckt

O = Rückseite bedruckt mit Funktionsbeleuchtung

Einsätze (nicht für 533 . . .)

Inserts (not for 533 . . .)

Éléments (auf 533 . . .)

Piastrine (non per . . .)

Elementes (non vale . . .)



Symbol Symbol Symbole Simbolo Símbolo	Benennung Description Dénomination Denominazione Denominación	Farbe Color Couleur Colore Color	Symbollage Mounting Pos. demon. Montaggio Montaje				Bestell-Nr. Order No. No. de cde N. di ordine Referencia	Symbol Symbol Symbole Simbolo Símbolo	Benennung Description Dénomination Denominazione Denominación	Farbe Color Couleur Colore Color	Symbollage Mounting Pos. demon. Montaggio Montaje				Bestell-Nr. Order No. No. de cde N. di ordine Referencia									
			normal	90° ↘	180° ↙	270° ↻					normal	90° ↘	180° ↙	270° ↻										
VIII. Geschwindigkeit																								
								Geschwindigkeitskontrolle Speed control Contrôle de vitesse Contr. veloc. Contr. de veloc.	gb/w			X				594 709								
									hgn	X						589 199								
CRUISE RES/SET	Fahrtgeschwindigkeit speichern Cruise Res / Set	sw/w	0				km/h 	Geschwindigkeitswechsel Speed changed -	gn	X						592 912								
km/h	Geschwindigkeit Speed -	gn		X				Langsam Slow	gn			X				590 580								
	Geschwindigkeit Speed Vitesse Velocità Velocidad	gn	X					Langsam Slow	gn			X				590 582								
					X								X			593 283								
SET	Geschwindigkeit setzen Ein/Aus Speed put on/off	gb/sw	X					Langsam Slow	or	X						591 677								
SET 	Geschwindigkeit speichern Speed save	sw/w	F				L	Langsam Slow	gn		X					589 517								
												X				591 318								
	Geschwindigkeitsanzeige Speed control	gb/sw	X				L	Langsam Slow	gn	X						591 831								
	Geschwindigkeitsbegrenzung Speed limiter Limiteur de vitesse Limitatore di velocità Limitador de velocidad	gb/w	X					Langsam Slow Lentement Lento Lento	gb/w	X						593 309								
												X						593 327						
		or	X						gn			X				593 040								
									or	x						589 668								
												X				593 619								
													X			589 482								
	Geschwindigkeitsbegrenzung el. Speed limiter el. Limiteur électronique de vitesse Limitatore di velocità elettr. Limitador eléctrico de velocid.	gb/w	X				L	Langsam Slow Lentement Lento Lento	gb/w	X						591 732								
											gn	X						596 107						

F = Rückseite bedruckt

0 = Rückseite bedruckt mit Funktionsbeleuchtung

Einsätze (nicht für 533 . . .)

Inserts (not for 533 . . .)

Éléments (auf 533 . . .)

Piastrine (non per . . .)

Elementes (non vale . . .)



Symbol Symbol Symbole Símbolo Símbolo	Benennung Description Dénomination Denominazione Denominación	Farbe Color Couleur Colore Color	Symbollage Mounting Pos. demon. Montaggio Montaje				Bestell-Nr. Order No. No. de cde N. di ordine Referencia	Symbol Symbol Symbole Símbolo Símbolo	Benennung Description Dénomination Denominazione Denominación	Farbe Color Couleur Colore Color	Symbollage Mounting Pos. demon. Montaggio Montaje				Bestell-Nr. Order No. No. de cde N. di ordine Referencia
			normal	90° ↷	180° ↷	270° ↷					normal	90° ↷	180° ↷	270° ↷	
	Langsam Slow Lentement Lento Lento	gn	X				595 969		Schneller Richtungswechsel Quickly change of direction	gn	X				587762
				X			595 186								
					X		596 135								
			X				596 185								
				X			595 501								
					X		590 066								
	Motorgeschwindigkeit Engine speed	gn		X			590 306		Umdrehung Verstellung Revolution adjustment	gn	X				590 074
	Motorgeschwindigkeit Engine speed	hgn			X		591 305		Umschaltung schnell/langsam Changeover fast/slow	gn	X				590 988
	Schnell Fast	gn	X				591 316								
				X			590 868								
	Schnell Fast	or	X				591 347								
					X		589 907								
		sw		X		589 940									
	Schnell Fast	gn	X				591 207								
				X			591 031								
		sw		X		594 765									
	Schnell Fast Rapide Veloce Rápido	gn	X				595 971								
				X			590 243								
						X	593 312								
	Schnell / Langsam Fast / slow	sw/w	O				589 488								
		w	X			587 989									
	Schnell / Langsam Fast / slow	gn	X				592 377								

F = Rückseite bedruckt

O = Rückseite bedruckt mit Funktionsbeleuchtung

Einsätze (nicht für 533 . . .)

Inserts (not for 533 . . .)

Éléments (auf 533 . . .)

Piastrine (non per . . .)

Elementes (non vale . . .)



Symbol Symbol Symbole Simbolo Símbolo	Benennung Description Dénomination Denominazione Denominación	Farbe Color Couleur Colore Color	Symbollage Mounting Pos. demon. Montaggio Montaje				Bestell-Nr. Order No. No. de cde N. di ordine Referencia	Symbol Symbol Symbole Simbolo Símbolo	Benennung Description Dénomination Denominazione Denominación	Farbe Color Couleur Colore Color	Symbollage Mounting Pos. demon. Montaggio Montaje				Bestell-Nr. Order No. No. de cde N. di ordine Referencia
			normal	90° ↘	180° ↙	270° ↗					normal	90° ↘	180° ↙	270° ↗	
	Abstützung re. ein-ausfahren Support right Extend-Retract Sortir-Rentrer étais droite Entrata-Uscita puntelli destro Soporte der., Retraer-Salir	gb/w				X	593 443		Baggerarm Excavator arm Bras de pelle Braccio escavatore Brazo de excavadora	gn	X				595 114
	Abstützung VL auf/ab - ein ausf. Support VL, up, down, drive in/Out	gb	X				592 583		baggern Excavate -	gn			X	594 446	
	Abstützung vorn links Support left front Étai AV gauche Puntello anter. Sinistro Soporte delantero izquierdo	gb/w	X				593 441		Freigabe Abstützung Unlock support Libération étais Consenso di puntellamento Desbloqueo soporte	gb/w	X			593 437	
												X		592 582	
	Abstützung vorn rechts Support right front Étai AV droite Puntello anter. Destro Soporte delantero derecho	gb/w	X				593 439		Gerätehalter Applicance holder Support pour appareils Supporto utensili Soporte de utensilios	gn	X			596 104	
	Abstützung VR auf/ab - ein, ausf. Support VR, up, down, drive in/out	gb	X				592 586		Greifer Grab Grappin Benna mordente Cuchara autom.	gn	X			596 092	
	ABV Kran an ABV crane on -	rt	X				592 524		Hakenwahl Selection of hook -	rt	X			596 155	
	ABV Kran aus ABV crane off -	rt	X				592 525		Heben gegen Anschlag Lift against stop Soulever contre la butée Sollevare fino arresto Subir hasta el tope	w	X			595 408	
	Anhänger kippen Trailer tilt	sw	X				587793		Heben/Senken Up/down Soulever/baisser Sollevare/abbas sare Subir/baja	w	X			595 405	
	Bagger Excavator	sw/w	F				591 044		Hebevorrichtung sperren Lock of lift device	w/sw	X			590 792	

F = Rückseite bedruckt

O = Rückseite bedruckt mit Funktionsbeleuchtung

Einsätze (nicht für 533 . . .)

Inserts (not for 533 . . .)

Éléments (auf 533 . . .)

Piastrine (non per . . .)

Elementes (non vale . . .)



Symbol Symbol Symbole Símbolo	Benennung Description Dénomination Denominazione Denominación	Farbe Color Couleur Colore Color	Symbollage Mounting Pos. demon. Montaggio Montaje				Bestell-Nr. Order No. No. de cde N. di ordine Referencia	Symbol Symbol Symbole Símbolo	Benennung Description Dénomination Denominazione Denominación	Farbe Color Couleur Colore Color	Symbollage Mounting Pos. demon. Montaggio Montaje				Bestell-Nr. Order No. No. de cde N. di ordine Referencia																					
			normal	90° ↘	180° ↙	270° ↗					normal	90° ↘	180° ↙	270° ↗																						
	Kabinenverriegelung Cabin bolting	rt	X						Kranausleger feststellen Crane boom fixing	gn	X					587836			gn	X					589 884											
	Kippen bis Anschlag Tip to stop Renverser jusqu' à la butée Ribaltare fino arresto Bocina, trasera	gb/w	X						Kranfunktion Crane operation Fonctionnement de la grue Funzione di gru Función de grua	gn	X					596 119		Kranfunktion Crane operation Fonctionnement de la grue Funzione di gru Función de grua	gn			X			594 711											
		w	X																		595 409															
	Kran entriegeln Crane unlock	gn	X						Last heben Lift load	gn	X					588 796		Last heben Lift load	gn	X					588 798											
	Kranausleger Crane boom adjustment	bl	X						Schaufel Bucket loader	gb/sw	X					590 798		Schaufel Bucket loader	gb/sw			X			594 412											
	Kranausleger 1 Crane boom 1	gn	X						Schaufel aufrichten Bucket loader roll back	w	X					589 899		Schaufel aufrichten Bucket loader roll back	w	X					592 702											
	Kranausleger 2 Crane boom 2	gn	X						Schaufel ausrichten Bucket loader roll back	w/sw	X					589 878		Schaufel ausrichten Bucket loader roll back	w/sw	X					590 794											
	Kranausleger 3 Crane boom 3	gn	X						Schaufel feststellen Bucket loader fixed	rt	X					589 895		Schaufel feststellen Bucket loader fixed	rt			X				589 042										
	Kranausleger 4 Crane boom 4	gn	X						Schaufel heben Bucket loader tip Renverser Ribaltare Bascular	w	X					589 893		Schaufel heben Bucket loader tip Renverser Ribaltare Bascular	w	X					595 406											
	Kranausleger 5 Crane boom 5	gn	X						Schaufel heben/senken Bucket loader header height	sw/w				F		589 876		Schaufel heben/senken Bucket loader header height	sw/w				F		591 619											

F = Rückseite bedruckt

O = Rückseite bedruckt mit Funktionsbeleuchtung

Einsätze (nicht für 533 . . .)

Inserts (not for 533 . . .)

Éléments (auf 533 . . .)

Piastrine (non per . . .)

Elementes (non vale . . .)



Symbol Symbol Symbole Simbolo Símbolo	Benennung Description Dénomination Denominazione Denominación	Farbe Color Couleur Colore Color	Symbollage Mounting Pos. demon. Montaggio Montaje				Bestell-Nr. Order No. No. de cde N. di ordine Referencia	Symbol Symbol Symbole Simbolo Símbolo	Benennung Description Dénomination Denominazione Denominación	Farbe Color Couleur Colore Color	Symbollage Mounting Pos. demon. Montaggio Montaje				Bestell-Nr. Order No. No. de cde N. di ordine Referencia
			normal	90° ↘	180° ↙	270° ↻					normal	90° ↘	180° ↙	270° ↻	
	Schaufel hoch Bucket loader lift	gn				X	594 758		Schaufel waagrecht Bucket loader horizontally Pelle horizontale Pala orizzontale Pala en horizontal	gn	X				595 428
	Schaufel Höheneinstellung Bucket loader hight adjustment	gn			X		590 676		Schaufelarm ret./travel Bucket loader arm ret./travel	gn				X	594 757
	Schaufel langsam Bucket loader slowly	gn	X				591 497		Schaufelfederung Bucket loader boom suspension	gn	X				592 375
	Schaufel Reserve Bucket loader - Reverse	gn	X				589 043		Schnell ausschütten Quick damp Déverser rapidement Rovesciare velocemente Vaciado rápido	w	X				595 407
				X			590 672								
	Schaufel ret./dig. Bucket loader ret./dig.	gn				X	594 759		Schwimmerstellung Float position	w/sw	X				590 790
	Schaufel Schwimmstellung Bucket loader float	gb/sw	X				590 805		Schwimmerstellung Float position Position du flotteur Posizione galleggiamento Posición del flotador	sw/w		O			591 644
		w/sw	X				592 189			gn	X				595 438
	Schaufel Schwimmstellung Bucket loader float	hgn			X		592 485		Schwimmerstellung Float position Position du flotteur Posizione galleggiamento Posición del flotador	w	X				592 703
		w	X				594 489			gn	X				592 425
	Schaufel Schwimmstellung Bucket loader float	w	X				594 489		Winde 1 Winch 1	gn	X				592 425
	Schaufel waagrecht Bucket loader horizontally Pelle horizontale Pala orizzontale Pala en horizontal	sw/w	O				591 654		Winde 1 und 2 Winch 1 and 2	gn	X				592 426

F = Rückseite bedruckt

O = Rückseite bedruckt mit Funktionsbeleuchtung

Einsätze (nicht für 533 . . .)

Inserts (not for 533 . . .)

Éléments (auf 533 . . .)

Piastrine (non per . . .)

Elementes (non vale . . .)



Symbol Symbol Symbole Simbolo Símbolo	Benennung Description Dénomination Denominazione Denominación	Farbe Color Couleur Colore Color	Symbollage Mounting Pos. demon. Montaggio Montaje				Bestell-Nr. Order No. No. de cde N. di ordine Referencia	Symbol Symbol Symbole Simbolo Símbolo	Benennung Description Dénomination Denominazione Denominación	Farbe Color Couleur Colore Color	Symbollage Mounting Pos. demon. Montaggio Montaje				Bestell-Nr. Order No. No. de cde N. di ordine Referencia							
			normal	90° ↘	180° ↙	270° ↗					normal	90° ↘	180° ↙	270° ↗								
	Winde 2 Winch 2	gn	X																			
	Zusatzgerät entsperren Accessory unit unlocked	rt	X																			
	Zusatzgerät geschlossen Accessory unit blocked	gn	X																			
	Zusatzgerät hoch sperren Accessory unit lift lock	sw/ww	X																			
	Zusatzgerät öffnen Accessory unit open Ouvrir l'appareil auxil. Aprire appar. suppl. Abrir la unidad auxil.	rt	X																			
		w/rt	F																			
	Zusatzgerät sperren Stufe 1, 2 Accessory unit lock stage	w/sw	X																			

F = Rückseite bedruckt

O = Rückseite bedruckt mit Funktionsbeleuchtung

Einsätze (nicht für 533 . . .)

Inserts (not for 533 . . .)

Éléments (auf 533 . . .)

Piastrine (non per . . .)

Elementes (non vale . . .)



Symbol Symbol Symbole Simbolo Símbolo	Benennung Description Dénomination Denominazione Denominación	Farbe Color Couleur Colore Color	Symbollage Mounting Pos. demon. Montaggio Montaje				Bestell-Nr. Order No. No. de cde N. di ordine Referencia	Symbol Symbol Symbole Simbolo Símbolo	Benennung Description Dénomination Denominazione Denominación	Farbe Color Couleur Colore Color	Symbollage Mounting Pos. demon. Montaggio Montaje				Bestell-Nr. Order No. No. de cde N. di ordine Referencia									
			normal	90° ↘	180° ↙	270° ↻					normal	90° ↘	180° ↙	270° ↻										
XI. Flüssigkeit																								
	Bremsöl Brake oil	hrt	X						Hydrauliköl Hydraulic oil	sw/w				F			591 034							
				X					Hydraulikölfilter Hydraulic oil filter	rt	X						589 508							
	Bremsöldruck Brake fluid pressure Pressure d'huile des freins Pressione olio freni Presión del líquido de frenos	gn	X						Hydraulikölstand Hydraulic oil level	rt	X						592 039							
	Drucköltemperatur Pressure oil temperature Température de l'huile de pression Temperatura olio in pressione Temperatura del aceite de presión	rt	X						Kraftstoff Fuel	gb/sw	X						591 038							
	Flüssigkeitsstand Liquid indicator	gb	X						Kraftstoff Fuel Carburant Combustible Combustible	drt	X						594 647							
		rt	X							gn			X				595 104							
				X						or	X						595 425							
										rt	X						595 157							
	Getriebeöldruck Transmission oil pressure Press. d'huile de la transmission Pressione olio trasmissione Presión del aceite de transmis.	rt	X						Kraftstoff aus Fuel tank empty	rt	X						594 775							
				X													591 284							
						X											594 422							
	Getriebeöl, Druck/Temperatur Transm. oil, press./temp. Huile, pression/température Press/temp. olio cambio Aceite cambio, presión/temp.	gb/w	X						Motor Kühlflüssigkeitsstand Engine coolant level	gn				X			588 996							
		rt	X														593 355							
	Getriebeöl, Druck/Temperatur Transm. oil, press./temp. Huile, pression/température Press/temp. olio cambio Aceite cambio, presión/temp.	rt	X						Motor Kühlflüssigkeitsstand Engine coolant level	gb/sw	X						591 829							
				X													595 197							
	Hydraulik Hydraulic	w/sw	X						Motorkühlmittel Engine coolant	gb	X						588 746							
										rt	X						590 072							

F = Rückseite bedruckt

O = Rückseite bedruckt mit Funktionsbeleuchtung

Einsätze (nicht für 533 . . .)

Inserts (not for 533 . . .)

Éléments (auf 533 . . .)

Piastrine (non per . . .)

Elementes (non vale . . .)



Symbol Symbol Symbole Simbolo Símbolo	Benennung Description Dénomination Denominazione Denominación	Farbe Color Couleur Colore Color	Symbollage Mounting Pos. demon. Montaggio Montaje				Bestell-Nr. Order No. No. de cde N. di ordine Referencia	Symbol Symbol Symbole Simbolo Símbolo	Benennung Description Dénomination Denominazione Denominación	Farbe Color Couleur Colore Color	Symbollage Mounting Pos. demon. Montaggio Montaje				Bestell-Nr. Order No. No. de cde N. di ordine Referencia									
			normal	90°	180°	270°					normal	90°	180°	270°										
	Öldruck ablassen Oil pressure lower	gb/sw	X						Tank 2 Tank 2 Réservoir 2 Serbatoio 2 Depósito 2	sw	X								594 447					596 112
	Öldruck erhöhen Oil pressure increase Augmentation de la pression d'huile Aumentare pressione olio Aumentar presión de aceite	gb/sw	X						Tank elek. Tank electronics	rt	X								594 450	592 033				
		gb/w	X																		595 120			
	Öldruck Motor Oil pressure motor	hrt	X						Tankanzeige Tank fuel display	gn	X								593 177	591 693				
		rt	X																					
				X																				
	Öldruck reduzieren Oil pressure reduce Diminution de la pression d'huile Diminuire pressione olio Reducir presión de aceite	gb/sw	X						Tankanzeige Tank fuel display	sw/w	0							594 449	592 365					
		gb/w	X																					
	Öldruckrichtung 1 und 2 Oil pressure direction 1 and 2	w	X						Tankinhalt Tank filling level Niveau du réservoir Livello serbatoio Nível del depósito	gn	X								594 734	596 222				
										rt	X													
													X											
	Öldruckrichtung aus Oil pressure direction off	w	X						Tankumschalter Tank selector switch Commutateur de réservoir Interruttore serbatoio Commutador de depósito	gn	X							594 733	596 298					
																					X			
	Ölschmierung Oil lubrication Lubrification, huile Lubrificazione, olio Lubrificación, aceite	gb/w	X						Transmissionsölfilter Transmission oil filter	gb/sw	X							595 110	591 891					
		gn	X																					
		rt	X																					
					X																			
	Ölservolenkung Oil servo steering	rt	X						Wasser Water Eau Acqua Agua	gn	X							587838	596 128					
																					X			
	Ölstand Oil level	hrt	X						Wasserstand WC Water level WC	rt	X							591 507	588 847					
									Wassertank Watertank	hgn			X						592 473					

F = Rückseite bedruckt

O = Rückseite bedruckt mit Funktionsbeleuchtung

Einsätze (nicht für 533 . . .)

Inserts (not for 533 . . .)

Éléments (auf 533 . . .)

Piastrine (non per . . .)

Elementes (non vale . . .)



Symbol Symbol Symbole Simbolo Símbolo	Benennung Description Dénomination Denominazione Denominación	Farbe Color Couleur Colore Color	Symbollage Mounting Pos. demon. Montaggio Montaje				Bestell-Nr. Order No. No. de cde N. di ordine Referencia	Symbol Symbol Symbole Simbolo Símbolo	Benennung Description Dénomination Denominazione Denominación	Farbe Color Couleur Colore Color	Symbollage Mounting Pos. demon. Montaggio Montaje				Bestell-Nr. Order No. No. de cde N. di ordine Referencia									
			normal	90°	180°	270°					normal	90°	180°	270°										
XII. Sonstige Miscellaneous Divers Varie Otros														Abstand aus Distance out -	gb/sw	X								592 989
	1. Anhängerfahrzeug 1st trailer 1er remorque 1h rimorchio 1h remolque	dgn	X			594 650		Abstand regulieren Distance regulate -	gn	X						594 452								
		gn	X			595 441																		
				X		594 737																		
	2. Anhängerfahrzeug 2nd trailer 2ième remorque 2h rimorchio 2h remolque	dgn	X			594 649		Abstand verstellen Schleifer Distance adjustment of cutting tool	gn			X				588 994								
				X		594 790																		
		gn	X			595 442																		
	A C Reheat Reheat	hgn			X	592 470		Abstandverstellung Distance adjustment gear	gn	X						591 501								
	Abfüllsicherung Filling safety device Sécurité de remplissage Valvola di travaso Seguro de relleno	gb/w	X			594 494		ABV Anhänger an ABV trailer on -	rt	X						592 523								
	Abgas Reading light	sw/w	O			589 494	ACC	ACC ACC xxx	sw			X				594 704								
	Abscheidetrommel Separator drum Tambour séparateur Tamburo separatore Tambor separador	gn	X			593 282		Achsenaufhängung Axle suspension	gb	X						589 903								
	Abschleppen On tow Remorquer Rimorchiare Remolcar	gb/w	X			593 422		Achsenerweiterung Axle springing	gb	X						593 436								
	Abstand Distance	gb/w	X			589 150	AXLE SHIFT	Achsenverschiebung Axle shift	sw/w	O						591 451								

F = Rückseite bedruckt

O = Rückseite bedruckt mit Funktionsbeleuchtung

Einsätze (nicht für 533 . . .)

Inserts (not for 533 . . .)

Éléments (auf 533 . . .)

Piastrine (non per . . .)

Elementes (non vale . . .)



Symbol Symbol Symbole Símbolo Símbolo	Benennung Description Dénomination Denominazione Denominación	Farbe Color Couleur Colore Color	Symbollage Mounting Pos. demon. Montaggio Montaje				Bestell-Nr. Order No. No. de cde N. di ordine Referencia	Symbol Symbol Symbole Símbolo Símbolo	Benennung Description Dénomination Denominazione Denominación	Farbe Color Couleur Colore Color	Symbollage Mounting Pos. demon. Montaggio Montaje				Bestell-Nr. Order No. No. de cde N. di ordine Referencia													
			normal	90° ↘	180° ↙	270° ↻					normal	90° ↘	180° ↙	270° ↻														
	Achtung Attention -	rt	X						Anzeige Indicator	or	X					592 520			Anzeige Indicator	or	X					592 168		
ADM	ADM ADM	rt	X						Anzeige Fahrspur Indicator fairway	or	X						588 854			Anzeige Fahrspur Indicator fairway	or	X					592 175	
ADM	ADM aus ADM off	rt	X						Anzeige Funktion Indicator function	gn			X				588 852			Anzeige Funktion Indicator function	gn			X			590 660	
	Äther Einspritzung Ether injection Injection d'ether Iniezione etere Inyección de éter	gb/w	X					594 463		Anzeige Funktion Indicator function	rt	X		X			594 760	591 755		Anzeige Funktion Indicator function	rt	X						
					X								593 313															
		rt	X					595 443																				
		sw	X					594 425																				
				X				593 632																				
		sw/w	O			F		592 367																	592 691			
ETHER	Äther Einspritzung Ether injection Injection d'ether Iniezione etere Inyección de éter	sw	X					593 641		Anzeige Funktion Indicator function	gb/sw	X					591 565		Anzeige Funktion Indicator function	rt	X							
					X								592 180															
	Anschlag Stop	or	X					590 608		Anzeige Funktion Indicator function	rt	X					592 037		Anzeige Funktion Indicator function	rt	X							
					X								592 900															
	Antenne ausfahren Extend antenna -	rt	X					593 435		Anzeige Kennlinie steigend Characteristics curve rising	gn				X		589 925	ASM	ASM ASM	gn	X					590 680		
ASR	Antischlupfregelung Anti slip regulation	gn	X					592 028		Anzeige Kennlinie steigend Characteristics curve rising	gn				X		589 925	ASR CROSS SET V	ASR ARS	gb	X					591 577		
	Antrieb Drive	gb	X					589 880																				

F = Rückseite bedruckt

O = Rückseite bedruckt mit Funktionsbeleuchtung

Einsätze (nicht für 533 . . .)

Inserts (not for 533 . . .)

Éléments (auf 533 . . .)

Piastrine (non per . . .)

Elementes (non vale . . .)



Symbol Symbol Symbole Simbolo Símbolo	Benennung Description Dénomination Denominazione Denominación	Farbe Color Couleur Colore Color	Symbollage Mounting Pos. demon. Montaggio Montaje				Bestell-Nr. Order No. No. de cde N. di ordine Referencia	Symbol Symbol Symbole Simbolo Símbolo	Benennung Description Dénomination Denominazione Denominación	Farbe Color Couleur Colore Color	Symbollage Mounting Pos. demon. Montaggio Montaje				Bestell-Nr. Order No. No. de cde N. di ordine Referencia		
			normal	90° ↘	180° ↙	270° ↗					normal	90° ↘	180° ↙	270° ↗			
ASR AUX	ASR AUX ASR AUX	sw/w	O						Auslauf Häcksel senken Exit chaffcutter trop	hgn			X			591 154	592 466
ATC OVER- RIDE	ATC umschalten ATC override	sw/w			F				Auslauf verstellen Exit adjustment	gn			X			591 425	588 992
	Aufgleisen vorne u. hinten Put on track front + rear	or	X						Ausleger automatisch senken Boom automatically trop	gn	X					592 045	588 255
	Auflagedruck Float pressure	hgn			X				Ausleger bewegen Boom moved	rt	X					592 461	590 050
	Aufnahmevorrichtung Cotton picking unit	sw/w			F				Ausleger einfahren Boom put in	gn	X					591 361	588 843
	AUS - EIN OFF - ON ARRET - MARCHÉ Spento - Acceso Des. - con.	gn	X						Ausleger einstellen Boom adjustment	gb	X					594 500	589 882
	Ausladevorrichtung Device for unloading	gn	X						Ausleger feststellen Boom fixing	gb	X					591 351	589 901
	Auslauf Häcksel Exit chaffcutter	gn	X						Ausleger verriegeln Boom lock Verrouillage flèche Bloccaggio braccio Bloqueo de pluma	gb/w	X					591 022	593 424
	Auslauf Häcksel Exit chaffcutter	hgn			X				Auswerfer H + S Ejector H + S Ejecteur de bottes H + S Espulsore H + S Expulsor H + S	gn	X					591 542	593 620

F = Rückseite bedruckt

O = Rückseite bedruckt mit Funktionsbeleuchtung

Einsätze (nicht für 533 . . .)

Inserts (not for 533 . . .)

Éléments (auf 533 . . .)

Piastrine (non per . . .)

Elementes (non vale . . .)



Symbol Symbol Symbole Símbolo	Benennung Description Dénomination Denominazione Denominación	Farbe Color Couleur Colore Color	Symbollage Mounting Pos. demon. Montaggio Montaje				Bestell-Nr. Order No. No. de cde N. di ordine Referencia	Symbol Symbol Symbole Símbolo	Benennung Description Dénomination Denominazione Denominación	Farbe Color Couleur Colore Color	Symbollage Mounting Pos. demon. Montaggio Montaje				Bestell-Nr. Order No. No. de cde N. di ordine Referencia
			normal	90° ↷	180° ↷	270° ↷					normal	90° ↷	180° ↷	270° ↷	
	Drehrichtung verstellen Rotation direction adjustment Inverseur de marche du rabatteur Invertire senso di rotazione Inversión de marcha	gn	X			592 910		Druckluftbehälter 1 Compressed air tank 1 Réservoir d'air comprimé 1 Serbatoio aria compressa 1 Depósito de aire comprimido 1	rt	X				593 401	
		hrt	X			591 503									
		sw/w		F		591 613									
	Drehrichtung verstellen. Rotation direction adjustment	gn	X			590 814		Druckluftbehälter 2 Compressed air tank 2 Réservoir d'air comprimé 2 Serbatoio aria compressa 2 Depósito de aire comprimido 2	rt	X					593 402
	Dreschspalt verstellen Concave adjustment	hgn		X		592 465		Druckluftbehälter 3 Compressed air tank 3 Réservoir d'air comprimé 3 Serbatoio aria compressa 3 Depósito de aire comprimido 3	rt	X					593 403
	Dreschwerk Threshing tool	gn	X			591 026		Druckluftthorn Compressed air horn Avertisseur sonore Avis, acust. aira compressa Bocina neumatica	gn	X					596 643
	Dreschwerk Threshing tool	gn	X			591 028		Druckluftvorrat Compressed air supply Réserve d'air comprimé Riserva aira compressa Reserva de aire comprimido	or	X					595 154
	Dreschwerk Threshing tool Mécánisme de batteuse Trebbiare Mecanismo trillador	gn	X			595 128		EDC Electronic diesel control	rt	X					588 871
		hrt		X		592 463									
	Dreschwerk schleifen Threshing tool saw	rt	X			591 018		EDC-Test Electronic diesel control - test	sw/w	0					592 360
	Drosselklappe Throttle valve Clapet d'étranglement Valvola a farfalla Válvula de estrangulación	gb/sw	X			594 469		EIN ON MARCHE Acceso Con.	gn	X					593 042
		gb/w	X			596 403			w	X					595 151
					X	594 797									
	Druckbehälter Compressed container < 5bar	rt	X			589 889		Einfüllung Pour in -	sw/w	0					591 656

F = Rückseite bedruckt

0 = Rückseite bedruckt mit Funktionsbeleuchtung

Einsätze (nicht für 533 . . .)

Inserts (not for 533 . . .)

Éléments (auf 533 . . .)

Piastrine (non per . . .)

Elementes (non vale . . .)



Symbol Symbol Symbole Simbolo Símbolo	Benennung Description Dénomination Denominazione Denominación	Farbe Color Couleur Colore Color	Symbollage Mounting Pos. demon. Montaggio Montaje				Bestell-Nr. Order No. No. de cde N. di ordine Referencia	Symbol Symbol Symbole Simbolo Símbolo	Benennung Description Dénomination Denominazione Denominación	Farbe Color Couleur Colore Color	Symbollage Mounting Pos. demon. Montaggio Montaje				Bestell-Nr. Order No. No. de cde N. di ordine Referencia			
			normal	90° ↘	180° ↙	270° ↗					normal	90° ↘	180° ↙	270° ↗				
	Einfüllung Pour in -	bl	X					CRUISE ON	Fahren an Cruise on	sw/w	0					596 161		591 449
	Einklappen Fold in -	gn	X					1 FP 2	Fahrerprogr. 1 oder 2 Drive progr. 1 or 2	gb	X					590 812		592 587
	Einstellung Ausladevorrichtung Adjustment for unloading device	gn	X					CRUISE ON/OFF	Fahrt Ein/Aus Cruise on / off	sw/w	0					591 020		591 382
EL	EL EL xxx	sw			X				Fahrtrichtungsanzeige Direction indicator Indicatore di direzione Indicador de dirección	gb/w	X					596 226		594 497 594 498 594 460 592 371 594 461 592 368
	Elektro Gas Electric gas	rt	X						Fahrtrichtungsanzeiger Direction indicator -	gn	X					590 002		593 345 594 727
	Entlüften Ventilate -	gn		X					Fahrtrichtungsanz. / Fensterheber Direction indicator / window lifter	bl		X				593 644		589 176 594 789 594 792 595 200 596 301 594 743
ETHER START	Ether Start Ether start	sw/w	0						Federung spannen Tension suspension -	sw	X					592 399		593 627
EXTRA	Extra Extra -	gb/w	X						Federungsanz. Indicator	gn	X					596 147		588 826
	E-Gas Diagnose E-gas, diagnosis	sw/w	0						Fensterheber Window lifter Lève-vitre Alzacristalli Alzacristales	gn	X					592 151		596 122 593 604 591 811

F = Rückseite bedruckt

0 = Rückseite bedruckt mit Funktionsbeleuchtung

Einsätze (nicht für 533 . . .)

Inserts (not for 533 . . .)

Éléments (auf 533 . . .)

Piastrine (non per . . .)

Elementes (non vale . . .)



Symbol Symbol Symbole Simbolo Símbolo	Benennung Description Dénomination Denominazione Denominación	Farbe Color Couleur Colore Color	Symbollage Mounting Pos. demon. Montaggio Montaje				Bestell-Nr. Order No. No. de cde N. di ordine Referencia	Symbol Symbol Symbole Simbolo Símbolo	Benennung Description Dénomination Denominazione Denominación	Farbe Color Couleur Colore Color	Symbollage Mounting Pos. demon. Montaggio Montaje				Bestell-Nr. Order No. No. de cde N. di ordine Referencia
			normal	90° ↘	180° ↔	270° ↙					normal	90° ↘	180° ↔	270° ↙	
	Fensterheber Window lifter Lève-vitre Alzacristalli Alzacristales	dgn	X				594 772	REC	Frischluff Fresh air Air frais Aria fresca Aire fresco	gn	X				594 467
			gb/w		X						594 771				
					X		592 238								
						X	592 765								
		gn	X				596 393								
sw	X				596 064										
	Fernseher / Video TV, video	sw/w	0						Funk Radio Radio Radiotelefono Radiotelegrafia	gb/w	X				594 448
										gn	X				595 153
	Feststellung Zahnradabstand Locking of gear distance	gn	X				591 499		Gabelträger heben Fork support to lift	or	X				591 227
				w	X							595 165			
	Feuer Fire	rt/w				F	591 158		Gabelträger hoch kippen Fork support up tilt	w	X				595 166
F	Feueralarm Ffire alarm	dgn	X				590 946		Gabelträger runter kippen Fork support down tilt	w	X				595 167
	Feueralarm Fire alarm Alarme incendio Allarme per incendio Alarma de fuego	rt	X				594 468		Gehbehinderung Disabled handicap	or	X				595 431
	Fifth wheel Fifth wheel Fifth wheel Fifth wheel Fifth wheel	sw/w				F	592 688		Gepäckraumklappe Boot lid Hayon coffre à bagages Cofano bagagli Tapa de la maleta	rt	X				595 130
	Förderband verstellen Delivery line adjustment	gn	X				591 571		Gepäckraumverriegelung Boot lock control	sw/w	0				592 133
	Fräsen Mill	gn				X	588 989		Gitter Screen Grille Griglia Rejilla	gn	X				596 205

F = Rückseite bedruckt

0 = Rückseite bedruckt mit Funktionsbeleuchtung

Einsätze (nicht für 533 . . .)

Inserts (not for 533 . . .)

Éléments (auf 533 . . .)

Piastrine (non per . . .)

Elementes (non vale . . .)



Symbol Symbol Symbole Simbolo Símbolo	Benennung Description Dénomination Denominazione Denominación	Farbe Color Couleur Colore Color	Symbollage Mounting Pos. demon. Montaggio Montaje				Bestell-Nr. Order No. No. de cde N. di ordine Referencia	Symbol Symbol Symbole Simbolo Símbolo	Benennung Description Dénomination Denominazione Denominación	Farbe Color Couleur Colore Color	Symbollage Mounting Pos. demon. Montaggio Montaje				Bestell-Nr. Order No. No. de cde N. di ordine Referencia
			normal	90° ↘	180° ↙	270° ↗					normal	90° ↘	180° ↙	270° ↗	
	Glocke aus Bell off Cloche Campanello Timbre	gn	X				595 134		Hangausgleich Slope compensation Compensateur de niveau Conguaglio pendio Estabilizador terreno inclinado	gn	X				595 549
						X	593 314								
		rt	X				595 129								
	Grabenfräse Trencher Fraise de tanchée Escavatrice a fresa Cavadova de zanjas	gb/w	X				596 160		Haspel Hasp	hgn			X		592 460
	Grobkehrtaufnahme Large item garbage pick-up Aspirateur grossier Assorbimento spazzature Recogida de basuras gruesas	gn	X				593 320		Haspel H + S Hasp H + S Rabatteur H + S Verricello H + S Devanadora H + S	gn	X				593 621
	Größe ändern Change size Modifier la dimension Modificare dimensioni Cambiar el tamaño	gn	X				596 124		Haspel horizontal Hasp, horizontal Rabatteur horizontal Verricello orizzontale Devanadora horizontal	gn	X				594 459
	Häcksler Chaffcutter	hrt	X				593 181		Haspel horizontal Hasp, horizontal Rabatteur horizontal Verricello orizzontale Devanadora horizontal	gn	X				595 125
				X								X	588 991		
						X					593 062	hgn			X
	Hänger abwerfen R-L	hgn			X		592 467		Haspel vertical Hasp, vertical	hgn			X		592 475
	Halmteiler Crop divider	hgn			X		592 471		Haspel Vor-Zurück Hasp forwards-backwards Rabatteur MARCHE AV/AR Verricello Avanti-Indietro Devanadora adelante-atrás	gn	X				592 875
	Haltewunsch Stop request Arrêt demandé Fermata a richiesta Demanda de parada	gn	X				594 430		Hauptantrieb Main drive Commande principale Trasmissione principale Accionamiento principal	gn	X				595 496
		sw/w	O				592 304								
	Hammer Hammer Masse Martello Martillo	gn	X				596 093		Hauptschalter Main switch Interruteur principal Interruttore principale Interruptor principal	gn		X			596 397
													X		596 398
														X	594 780
											rt	X			588 872
											sw	X			596 179
			O			593 602									

F = Rückseite bedruckt

O = Rückseite bedruckt mit Funktionsbeleuchtung

Einsätze (nicht für 533 . . .)

Inserts (not for 533 . . .)

Éléments (auf 533 . . .)

Piastrine (non per . . .)

Elementes (non vale . . .)



Symbol Symbol Symbole Simbolo Símbolo	Benennung Description Dénomination Denominazione Denominación	Farbe Color Couleur Colore Color	Symbollage Mounting Pos. demon. Montaggio Montaje				Bestell-Nr. Order No. No. de cde N. di ordine Referencia	Symbol Symbol Symbole Simbolo Símbolo	Benennung Description Dénomination Denominazione Denominación	Farbe Color Couleur Colore Color	Symbollage Mounting Pos. demon. Montaggio Montaje				Bestell-Nr. Order No. No. de cde N. di ordine Referencia
			normal	90° ↘	180° ↙	270° ↻					normal	90° ↘	180° ↙	270° ↻	
	Hebedach Lifting roof Toit ouvrant Tetto apribile Techo levadizo	gn	X						Horn Horn Sonor Avvisatore acustico Bocina	gn	X				596 196
										sw	X				596 176
												0			593 605
										sw/w	0				591 152
	Heizung Heater Chauffage Ris caldamento Calefacción	gn	X						Horn rückwärts Horn, backwards Avertisseur arrière Avvisatore acustico posteriore Bocina, trasera	gb/sw	X				594 478
										gb/w	X				595 400
										sw/w	F				592 364
											0				591 628
	Hilfe Rollstuhlfahrer Wheelchair user help	gb	X						Hosteßruf Hostess call Appel service Chiamata Hostell Llamada servicio	gn	X				596 635
	Hilfssteuerpumpe Auxiliary control pump Pompe de commande auxiliare Pompa di controllo ausiliaria Bomba de control auxiliar	rt	X						Hubkraftverstärkung Lift force strengthening	or	X				592 047
	Hilfstrittbrett Auxiliary step Marchepied auxiliaire Marciapiede ausiliario Estribo auxiliar	gn	X						Hydrolüfter Aus Hydraulic fan off ARRET refroid. de l'hydraul. Idroventilatore spento Desconectar ventilación hidrául.	gb/sw	X				593 290
		rt	X												595 131
	Hitch Hitch Hitch Hitch Hitch	gn	X						Hydr. Anschluß Hydr. Connection Raccordement hydr. Attacco idraulico Empalme hidráulico	gn	X				596 105
	Hobeln Plane	gn		X					Indusi Indusi	or	X				592 043
	Hoch High -	gb/sw	X						Irisblende geschlossen Iris shield locked	gn			X		589 286
		gn	X												591 317
		w	X												594 730
	Höhenverstellung High lifting Levage Regolazione altezza Regulación altura	gb/w	X						Kabinendach hoch Cabin roof	rt	X				596 090

F = Rückseite bedruckt

0 = Rückseite bedruckt mit Funktionsbeleuchtung

Einsätze (nicht für 533 . . .)

Inserts (not for 533 . . .)

Éléments (auf 533 . . .)

Piastrine (non per . . .)

Elementes (non vale . . .)



Symbol Symbol Symbole Simbolo Símbolo	Benennung Description Dénomination Denominazione Denominación	Farbe Color Couleur Colore Color	Symbollage Mounting Pos. demon. Montaggio Montaje				Bestell-Nr. Order No. No. de cde N. di ordine Referencia	Symbol Symbol Symbole Simbolo Símbolo	Benennung Description Dénomination Denominazione Denominación	Farbe Color Couleur Colore Color	Symbollage Mounting Pos. demon. Montaggio Montaje				Bestell-Nr. Order No. No. de cde N. di ordine Referencia
			normal	90° ↘	180° ↙	270° ↗					normal	90° ↘	180° ↙	270° ↗	
	Kaffsieb Chaffter	hgn			X	592 429		Kipper Ladeflächerückstellung Tipper to horizontal Rappel de benne Ritorno cassone ribaltabile Volcador a posición de marcha	gn			X		592 906	
										rt			X		592 095
	Kamera Camera Caméra Telecamera Cámara	gn	X			595 421		Klingel Rollstuhlfahrer Bell wheelchair user	gb	X				589 181	
	Kehrichtaufnahme Garbage pick-up Réception des ordures Ricezione spazzature Recogida de basuras	gn	X			596 125		Körnersieb Grain-sieve	hgn			X		592 428	
	Kehrmittelaufnahme bestätigen Operate garbage pick-up Actioner le dispositif de réception des immondices Azionare ricezione spazzature Accionar la recogida de basuras	gn	X			594 488		Kohlebürsten Verschleißanzeige Carbon brushes worn Indicateur d'usure des charbons Indicatore usura spazzole carbone Indicador desgaste escobillas	rt	X				592 919	
	Kinderwagen Perambulator Landau Vettura bambina Coche para niños	bl	X			595 115		Kolbeneinfahrt Put in piston	sw	X				589 772	
												X		589 320	
	Kipper Tipper Benne basculante Cassone ribaltabile Volquete	gn	X			596 469		Korntank aus Grain tank off	rt	X				591 164	
		rt			X										
	Kipper in Korntank Tipper in grain tank	gn	X			591 353		Korntank dreiviertel voll Grain tank three quarters full	gn	X				593 342	
									hgn		X			594 724	
	Kipper Ladeflächerückstellung Tipper to horizontal	gn			X	590 422		Korntank entleeren Grain tank empty	gn	X				592 096	
										X				593 188	
									hrt		X			593 341	
												X		593 174	
									rt	X			X	593 330	
		X				593 329									
	Kipper Ladeflächerückstellung Tipper to horizontal	gn	X			590 443		Korntank halbvoll Grain tank half full	gn	X				593 343	
				X						hgn		X		594 725	

F = Rückseite bedruckt

O = Rückseite bedruckt mit Funktionsbeleuchtung

Einsätze (nicht für 533 . . .)

Inserts (not for 533 . . .)

Éléments (auf 533 . . .)

Piastrine (non per . . .)

Elementes (non vale . . .)



Symbol Symbol Symbole Simbolo Símbolo	Benennung Description Dénomination Denominazione Denominación	Farbe Color Couleur Colore Color	Symbollage Mounting Pos. demon. Montaggio Montaje				Bestell-Nr. Order No. No. de cde N. di ordine Referencia	Symbol Symbol Symbole Simbolo Símbolo	Benennung Description Dénomination Denominazione Denominación	Farbe Color Couleur Colore Color	Symbollage Mounting Pos. demon. Montaggio Montaje				Bestell-Nr. Order No. No. de cde N. di ordine Referencia														
			normal	90° ↘	180° ↙	270° ↻					normal	90° ↘	180° ↙	270° ↻															
	Korntank öffnen Grain tank open	gn			X				Leiter Ladder Echelle Scala Escalera	gn	X					589 315					596 204								
	KT-Schneke KT-snail	hrt	X						Lenkautomat Steering device automatic Direction automatique Sterzo automatico Aparato de dirección automática	gn	X					593 182				593 281									
				X														593 335					590 658						
						X																							
	Küche Kitchen	gn	X						Lenkautomat Steering device automatic	sw/w			F									591 582	591 032						
	Kühlschrank Refrigerator Réfrigérateur Frigorifero Nevera	bl	X						Lenkautomat Steering device automatic Direction automatique Sterzo automatico Aparato de dirección automática	gn	X												595 160	595 121					
		gn	X							sw/w	0														596 613	591 636			
	Kühlung Welle Sprinkler drive	gb	X						Lenkrad Steering wheel	rt	X													589 075	589 504				
	Ladefläche kippen Load wall tilt	hgb			X				Lenkrad Steering wheel	gb/sw	X														592 481	590 802			
	Ladefläche öffnen Load wall open	rt	X						Lenkradverstellung Steering wheel adjustment	gb	X															589 776	589 581		
	Ladefläche runter Load wall up	rt	X						Lenksperr Steering lock Blocage de la direction Sbarramento sterzo Bloqueo de la dirección	gb/w	X																588 748	594 492	
	Lautsprecher aus Loudspeaker out	gn			X				Lenkungsblockierung Steering blocking	gn	X																	587317	591 569

F = Rückseite bedruckt

0 = Rückseite bedruckt mit Funktionsbeleuchtung

Einsätze (nicht für 533 . . .)

Inserts (not for 533 . . .)

Éléments (auf 533 . . .)

Piastrine (non per . . .)

Elementes (non vale . . .)



Symbol Symbol Symbole Simbolo Símbolo	Benennung Description Dénomination Denominazione Denominación	Farbe Color Couleur Colore Color	Symbollage Mounting Pos. demon. Montaggio Montaje				Bestell-Nr. Order No. No. de cde N. di ordine Referencia	Symbol Symbol Symbole Simbolo Símbolo	Benennung Description Dénomination Denominazione Denominación	Farbe Color Couleur Colore Color	Symbollage Mounting Pos. demon. Montaggio Montaje				Bestell-Nr. Order No. No. de cde N. di ordine Referencia
			normal	90° ↘	180° ↙	270° ↻					normal	90° ↘	180° ↙	270° ↻	
	Lenkungsverriegelung Steering lock Verrouillage de la direction Bloccasterzo Bloqueo de dirección	gn	X					Magnet Magnet	hgn	X				590 281	
		sw	X												
	LMB verstellen Swing boom	rt	X					Magnetsicherung Magnet safeguarding	hgn			X		592 464	
	Logo „ALS“ ALS logo	gn		X			MAN	Manuell Manual	gn	X				590 684	
	Logo „G“ G logo	rt	X					Maßkontrolle Ripper control	gb	X				592 790	
	Mährescher Combine harvester	sw/gb			F			Messerschleifer Blade grinder Affûteuse de lames Affilatrice per lame Afiladora de cuchillas	gn	X				595 497	
	Mähwerk einfahren Mower put in	hgn			X			Metallsucher AUS Metal detector OFF Décteur de métal Arrêt Riceratore metalli spento Detector de metal D	gn	X				595 498	
	Mähwerk Höhenverstellung Mower hight adjustment	gn	X					Metallsucher EIN Metal detector ON	gn	X				590 808	
									rt	X				595 499	
	Mähwerk verstellen Mmower adjustment	hgn			X			Meßeinrichtung Measuring instrument	Rt			X		589 888	
									rt	X				589 909	
	Mähwerkzylinder Einstellung Treshing cylinder variator	gn			X		Mode	Mode Mode	hgn	X				589 197	

F = Rückseite bedruckt

O = Rückseite bedruckt mit Funktionsbeleuchtung

Einsätze (nicht für 533 . . .)

Inserts (not for 533 . . .)

Éléments (auf 533 . . .)

Piastrine (non per . . .)

Elementes (non vale . . .)



Symbol Symbol Symbole Simbolo Símbolo	Benennung Description Dénomination Denominazione Denominación	Farbe Color Couleur Colore Color	Symbollage Mounting Pos. demon. Montaggio Montaje				Bestell-Nr. Order No. No. de cde N. di ordine Referencia	Symbol Symbol Symbole Simbolo Símbolo	Benennung Description Dénomination Denominazione Denominación	Farbe Color Couleur Colore Color	Symbollage Mounting Pos. demon. Montaggio Montaje				Bestell-Nr. Order No. No. de cde N. di ordine Referencia
			normal	90° ↷	180° ↷	270° ↷					normal	90° ↷	180° ↷	270° ↷	
	Monitor Monitor Moniteur Monitor Monitor	gn	X						Regulierung Dreschwerk To mill	sw/gb			F		591 162
	Muldenkipper Skip dumper truck	sw/w	O						Reifendruckregler Aus Tire pressure governor off ARRET régulateur pres. Pneus Regol. press. gomme spento Descon. regul. Presión pneumáticos	gb/sw	X				593 291
	Notlenkung Emergency steering Direction de secours Direzione di emergenza Dirección de emergencia	gb/sw	X						Retarder Retarder Ralentisseur Rallentatore Retarder	gn	X				594 417
		gb/w	X							gn	X				
	Notlenkung Emergency steering Direction de secours Direzione di emergenza Dirección de emergencia	rt	X						Retarder Retarder Ralentisseur Rallentatore Retarder	gb/w	X				591 844
										gn	X				594 429
P	Parken Park (automatic transmission)	drt				X			Retarder Aus Retarder Out Ralentisseur Rallentatore Retarder	gb/w	X				593 496
PRIO	Priorität Priority	gn	X						Retarder elekt. Retarder el. -	or	X				593 642
										rt	X				589 309
INHI BIDOR	Prüftaste Check key Touche de contrôle Tasto di prova Tecla de ensayo	gn	X						Reversieren Reverser	hgn			X		592 486
R L	R - L Trailer detach	hgn			X				Rohr knicken Snap pipe -	rt	X				595 162
	Radio/Musik Radio/music Radio/Musique Radio/musica Radio/música	gn	X						Rollstuhl angeschnallt Wheelchair to strap	rt	X				589 170

F = Rückseite bedruckt

O = Rückseite bedruckt mit Funktionsbeleuchtung

Einsätze (nicht für 533 . . .)

Inserts (not for 533 . . .)
 Éléments (auf 533 . . .)
 Piastrine (non per . . .)
 Elementes (non vale . . .)



Symbol Symbol Symbole Símbolo	Benennung Description Dénomination Denominazione Denominación	Farbe Color Couleur Colore Color	Symbollage Mounting Pos. demon. Montaggio Montaje				Bestell-Nr. Order No. No. de cde N. di ordine Referencia	Symbol Symbol Symbole Símbolo	Benennung Description Dénomination Denominazione Denominación	Farbe Color Couleur Colore Color	Symbollage Mounting Pos. demon. Montaggio Montaje				Bestell-Nr. Order No. No. de cde N. di ordine Referencia						
			normal	90° ↘	180° ↙	270° ↻					normal	90° ↘	180° ↙	270° ↻							
	Rollstuhlbenutzer Wheelchair user	gb/sw	X						Sandstreuer Sand spreader	or	X					590 248					592 035
	Ruder Rockshaft	gn	X						Sanduhr stop Hourmeter	gb	X					588 192					588 985
	Ruder Rockshaft	gn	X						Schälmesser Peeling knife Couteau à décortiquer Lama scorteggiatrice Cuchilla descortezadora	gn	X					589 079					596 188
	Ruder entriegeln Rockshaft unlocked	gn			X				Schleifverstellung Sharpen adjustments	gn	X					590 302					591 236
	Ruder hoch Rockshaft up -	or	X						Schleppbetrieb Trail operation	or	X					593 628					592 049
			X								593 064										
		sw	X			X				591 077											
		sw/w				X				592 996											
	Ruder senken Rockshaft down	gn			X				Schmierung Zahnräder Greasing of gears -	w	X					590 308					594 437
					X							589 936									
	Ruder senken Rockshaft down	sw	X						Schmutzkratzer Dirt scraper Gratteur Raschiatore Rascador de lodos	gn	X					589 841					593 323
					X							589 906									
	Ruder senken Rockshaft down	gb			X				schneiden / fräsen cut / mill -	gn	X					590 577					596 203
			sw	X								594 793									
	Ruder zurück stellen Rockshaft put back -	gn	X						Schneidwerkantrieb Drive for cutting tool	hrt			X			594 490					592 468
				X								595 176									

Einsätze (nicht für 533 . . .)

Inserts (not for 533 . . .)

Éléments (auf 533 . . .)

Piastrine (non per . . .)

Elementes (non vale . . .)



Symbol Symbol Symbole Simbolo Símbolo	Benennung Description Dénomination Denominazione Denominación	Farbe Color Couleur Colore Color	Symbollage Mounting Pos. demon. Montaggio Montaje				Bestell-Nr. Order No. No. de cde N. di ordine Referencia	Symbol Symbol Symbole Simbolo Símbolo	Benennung Description Dénomination Denominazione Denominación	Farbe Color Couleur Colore Color	Symbollage Mounting Pos. demon. Montaggio Montaje				Bestell-Nr. Order No. No. de cde N. di ordine Referencia	
			normal	90° ↘	180° ↙	270° ↗					normal	90° ↘	180° ↙	270° ↗		
	Schneidwerkzeug Cutting tool Faucheuse Utensile da taglio Herramienta de corte	gn	X						Schulbus School bus Bus de ramassage scolaire Scuolabus Autobus escolar	gb/w	X					595 144
										rt	X					589 310
	Schneidwerkzeug hoch - tief Cutting tool, up - down Montée/descente faucheuse Utensile da taglio alto - basso Herramienta de corte arriba - abajo	rt	X						Seilwinde Cable winch Treuil à câble Verricello Torno de cable	gb/sw	X					593 616
	Schneidwerkzeug reversier Cutting tool, reversing Renverseur de faucheuse Utensile da taglio reversibile Herramienta de corte reversible	gn	X						Seilwinde Cable winch Treuil à câble Verricello Torno de cable	gn	X					596 187
													X			594 713
	Schneidwerkzeug verriegelt Cutting tool locked Verrouillage outil de coupe Utensile da taglio bloccato Herramienta de corte bloqueado	rt	X						Sicherheitsgurt Seat belt	sw/w	F					591 322
	Schrägmähwerk links Sloping mower left	gn	X						Siebverlängerung Sieve extension	hgn			X			592 427
	Schrägmähwerk rechts Sloping mower right	gn	X					SMOG	SMOG SMOG	rt	X					590 827
	Schrägstellung links Tipped to left Déversement latéral (à gauche) Inclinazione laterale sinistro Posición oblicua, izquierdo	gb/w	X						Sonnenrollo Sun curtain	sw/w	O					592 149
	Schrägstellung rechts Tipped to right Déversement latéral (à droite) Inclinazione laterale destra Posición oblicua, derecha	gb/w	X						Spaltabstand verstellen Distance adjustment	gn				X		588 998
	Schüttler Shaker	hrt	X						Spannung Voltage -	rt	X					594 421

F = Rückseite bedruckt

O = Rückseite bedruckt mit Funktionsbeleuchtung

Einsätze (nicht für 533 . . .)

Inserts (not for 533 . . .)

Éléments (auf 533 . . .)

Piastrine (non per . . .)

Elementes (non vale . . .)



Symbol Symbol Symbole Simbolo Símbolo	Benennung Description Dénomination Denominazione Denominación	Farbe Color Couleur Colore Color	Symbollage Mounting Pos. demon. Montaggio Montaje				Bestell-Nr. Order No. No. de cde N. di ordine Referencia	Symbol Symbol Symbole Simbolo Símbolo	Benennung Description Dénomination Denominazione Denominación	Farbe Color Couleur Colore Color	Symbollage Mounting Pos. demon. Montaggio Montaje				Bestell-Nr. Order No. No. de cde N. di ordine Referencia
			normal	90° ↘	180° ↙	270° ↗					normal	90° ↘	180° ↙	270° ↗	
MEM	Speicher Memory	gn	X					Stabilisierungsmitte Stabilization center Milieu de stabilisation Centro di stabilizzazione Centro de estabilización	gn	X				596 620	596 197
MEMO OFF	Speicher aus Memory off	sw/w	F					Stark Strength	or/sw	X				591 433	589 506
	Sperren Lock	sw/w			F			Steckdose Socket Prise de courant Presa di corrente Enchufe	gn		X			591 371	596 106
	Sprühen Injection	sw/w			F			Steuerhebel Control lever Lever de commande Leva di comando Palanca de mando	gn	X				591 363	594 741
	Sprühwasser Spray water Arrosage Acqua di lavaggio Agua pulverizada	gn	X					Steuerpumpe Control pump Pompe de commande Pompa de controllo Bomba de control	rt	X				593 302	596 150
	Sprühwasser Aufnahme Spray water suction Arrosage sur l'aspirateur Assorbimento acqua sporca Agua pulverizada recogida	gn	X					Steuerung aus Steering off	or			X		593 321	589 206
	Sprühwasser Tellerbesen Spray water circular broom Arrosage au disque balayeur Innaffiamento su spazzatrice circol. Agua pulverizada escoba circ.	gn	X				STOP	Stoppen Stop -	gn			X		593 322	596 340
	Sprühwasser Walzenbesen Spray water roller broom Arrosage au rouleau balayeur Innaffiamento su rullo spazzatore Agua pulverizada rodillo escoba	gn	X					Streuautomat Grit spreader Epandeur automatique Spargitrice automatica Esparcidor automático	gn	X				593 324	594 434
	Spurrollen auf/ab Trail rolls up/down	or	X					Streublech einstellen Discharge adjust	hgn			X		592 041	594 419

F = Rückseite bedruckt

O = Rückseite bedruckt mit Funktionsbeleuchtung

Einsätze (nicht für 533 . . .)

Inserts (not for 533 . . .)

Éléments (auf 533 . . .)

Piastrine (non per . . .)

Elementes (non vale . . .)



Symbol Symbol Symbole Simbolo Símbolo	Benennung Description Dénomination Denominazione Denominación	Farbe Color Couleur Colore Color	Symbollage Mounting Pos. demon. Montaggio Montaje				Bestell-Nr. Order No. No. de cde N. di ordine Referencia	Symbol Symbol Symbole Simbolo Símbolo	Benennung Description Dénomination Denominazione Denominación	Farbe Color Couleur Colore Color	Symbollage Mounting Pos. demon. Montaggio Montaje				Bestell-Nr. Order No. No. de cde N. di ordine Referencia
			normal	90° ↘	180° ↙	270° ↻					normal	90° ↘	180° ↙	270° ↻	
	Tellerbesen Circular broom Balais-disque Scopa circolare Escopa circular	gn	X					Türöffner Door opener Ouvre-portes Apertura porte Abrepuertas	gn	X				595 967	
									rt	X				596 152	
									sw	X				596 178	
TEST	Test Test Test Prova Test	gn	X					Türöffner Door opener Ouvre-portes Apertura porte Abrepuertas	gn	X				596 194	
		sw/w	0											592 306	
 TEST	Test elektr. Luftfederung Test el. Air suspension	sw/w	0					Türöffner aus Door opener off	rt	X				588 845	
TRAC LOCK	Trac lock Trac lock	sw/w	0					Türöffner Tür 1 Door opener, door 1	sw/w	F				589 532	
	Traktor vorwärts Tractor forward	gb	X					Türöffner Tür 1 Door opener, door 1 Ouvre-portes, porte 1 Apertura porte - Porte 1 Abrepuertas, puerta 1	gn	X				589 077	
									rt	X				594 445	
	Transportband Transportation line	rt	X					Türöffner Tür 2 Door opener, door 2	gn	X				595 852	
									rt	X				594 444	
	Transportband Stufe 2 Transportation line step 2	gn	X					Türverstellung Door adjustment	gn	X				589 886	
	Treppe ausfahren Step run-out Escalier mobile Scala estraib. Escalera telescopica	gn	X					TV TV TV TV TV	gn	X				594 439	
	Tür verschieben Door moved	gn	X					Überkehr Change running direction	hrt	X				593 183	
														593 336	
												X		593 058	

F = Rückseite bedruckt

0 = Rückseite bedruckt mit Funktionsbeleuchtung

Einsätze (nicht für 533 . . .)

Inserts (not for 533 . . .)

Éléments (auf 533 . . .)

Piastrine (non per . . .)

Elementes (non vale . . .)



Symbol Symbol Symbole Simbolo Símbolo	Benennung Description Dénomination Denominazione Denominación	Farbe Color Couleur Colore Color	Symbollage Mounting Pos. demon. Montaggio Montaje				Bestell-Nr. Order No. No. de cde N. di ordine Referencia	Symbol Symbol Symbole Simbolo Símbolo	Benennung Description Dénomination Denominazione Denominación	Farbe Color Couleur Colore Color	Symbollage Mounting Pos. demon. Montaggio Montaje				Bestell-Nr. Order No. No. de cde N. di ordine Referencia
			normal	90°	180°	270°					normal	90°	180°	270°	
	Überlast Warneinrichtung Warning facility for overload	gb	X				590 596	VS VS VS xxx	VS VS xxx	gn	X				594 413
		gn	X				590 990								
		rt	X				596 091								
		w/sw	X				595 150								
	Umdrehen Turn over	gn	X					Walzenabstand Roller distance	gn	X					591 024
Blackout Override	Umgehung bei Gesamtausfall Blackout Override Dériv. en cas de défail. Totale Overdrive escluso in caso di blackout Desvío en caso de blackout	gb/sw	X				593 292		Wandlerkupplung Converter clutch Convertisseur-embayage Convertitore di coppia Embrague de convertidor	gn	X				593 405
	Umlaufbesen verstellen Rotating broom adjustment	gn	X				591 537		Wandlerkupplung öffnen Converter clutch open Déblocage conv. d'embrayage Apertura convertitore di coppia Abrir embrague de convertidor	gb/w	X				593 404
							590 210								595 420
	Umluft Circulation	gn	X				590 594	WC WC -	WC WC -	gn	X				595 420
OVER- RIDE	Umschaltung Changeover	sw/w			F		591 445	<u>SET</u> RESUME	Wiederaufnahme Set resume	sw/w			F		591 447
<u>4CYLS</u> <u>2CYLS</u>	Umschaltung 2/4 Changeover 4 cycls 2 cycls	sw/w			F		591 423	<u>RESUME</u> OFF	Wiederaufnahme aus Off resume	sw/w		F			590 824
	Verst.programm für Mäher Header floating program Décalage du releveur d'épis Unità regolazione mietitrice Programma de flotación del cabezal	gn			X		592 905		Zange verstellen Pliers adjustment	gn				X	588 788
	Vorspannung Spring preload	gn			X		590 670		Zentralverriegelung Door lock control	gn	X				591 584
									Zylinderverstellung Cylinder adjustment	or	X				596 154
										rt	X				591 215

F = Rückseite bedruckt

O = Rückseite bedruckt mit Funktionsbeleuchtung

Einsätze für Baureihe 533

Inserts 533
Éléments 533
Piastrine 533
Elementes 533



Symbol Symbol Symbole Simbolo Símbolo	Benennung Description Dénomination Denominazione Denominación	Farbe Color Couleur Colore Color	Symbollage Mounting Pos. demon. Montaggio Montaje				Bestell-Nr. Order No. No. de cde N. di ordine Referencia	Symbol Symbol Symbole Simbolo Símbolo	Benennung Description Dénomination Denominazione Denominación	Farbe Color Couleur Colore Color	Symbollage Mounting Pos. demon. Montaggio Montaje				Bestell-Nr. Order No. No. de cde N. di ordine Referencia	
			normal	90°	180°	270°					normal	90°	180°	270°		
II. Wischen-Waschen Wipe-Wash Essuie-vitre/lave-vitre Tergivetro-Lavaggio Limpiaparabrisas-Lavaparabrisas								Scheibenwischer/-wascher Window wiper/washer	bl	X						588 056
	Heckscheibenwischer Rear window wiper	gr	X					Scheibenwischer/-wascher Window wiper/washer	gr	X					588 626	
	Heckscheibenwischer Rear window wiper	gr	X					Scheibenwischer/-wascher Window wiper/washer	gr	X					588 042	
	Heckscheibenwischer/ -wascher Rear window wiper / washer	gr	X					Scheinwerferwischer/-wascher Headlamp wiper/washer	gr	X					588 398	
	Heckscheibenwischer/ -wascher Rear window wiper / washer	bl	X												588 718	
	Heckscheibenwischer/ -wascher Rear window wiper / washer	gr	X												588 710	
	Heckscheibenwischer/ -wascher Rear window wiper / washer	bl	X												588 071	
	Heckscheibenwischer/ -wascher Rear window wiper / washer	gr	X												588 303	
	Interwallwischen Intermittant wiper	gr	X												588 312	
	Scheibenwischer Window wiper	gr	X												588 627	
	Scheibenwischer/ -wascher Windscreen wiper / washer	gr	X												587 751	

Einsätze für Baureihe 533

Inserts 533
Éléments 533
Piastrine 533
Elementes 533









Symbol Symbol Symbole Simbolo Símbolo	Benennung Description Dénomination Denominazione Denominación	Farbe Color Couleur Colore Color	Symbollage Mounting Pos. demon. Montaggio Montaje				Bestell-Nr. Order No. No. de cde N. di ordine Referencia	Symbol Symbol Symbole Simbolo Símbolo	Benennung Description Dénomination Denominazione Denominación	Farbe Color Couleur Colore Color	Symbollage Mounting Pos. demon. Montaggio Montaje				Bestell-Nr. Order No. No. de cde N. di ordine Referencia
			normal	90° ↘	180° ↙	270° ↗					normal	90° ↘	180° ↙	270° ↗	
	Innenbeleuchtung Interior light	bl	X				588 715		Linienanzeige Line indicator	gr	X				588 322
		gr	X				588 688								
	Innenbeleuchtung mittel Interior light medium	gr	X				588 581		Nebelscheinwerfer Fog lamp	gr	X				588 394
	Innenbeleuchtung schwach Interior light dim	gr	X				588 336		Nebelschlußleuchte Fog warning lamp	gr	X				588 310
	Kofferraumbeleuchtung Trunk light	gr	X				587 750		Nebelschlußleuchte Fog warning lamp	gr	X				588 175
	Ladenflächenlicht Light for loading area	bl	X				588 137		Positionsleuchte Position lamp	gr	X				587 489
	Lampenprüfung Lamp test	gr	X				588 550		Positionsleuchte Position lamp	bl	X				588 087
	Leselampe Reading light	gr	X				588 334		Rundumkennleuchte Rotary beacon	bl	X				588 136
										gr	X				588 049
	Licht Light	gr	X				588 586		Rundumkennleuchte Rotary beacon	gr	X				588 628
	Licht Light	gr	X				588 097		Rundumkennleuchte Rotary beacon	bl	X				588 720
										gr	X				588 712

Einsätze für Baureihe 533

Inserts 533
Éléments 533
Piastrine 533
Elementos 533

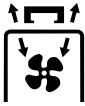









Symbol Symbol Symbole Simbolo Símbolo	Benennung Description Dénomination Denominazione Denominación	Farbe Color Couleur Colore Color	Symbollage Mounting Pos. demon. Montaggio Montaje				Bestell-Nr. Order No. No. de cde N. di ordine Referencia	Symbol Symbol Symbole Simbolo Símbolo	Benennung Description Dénomination Denominazione Denominación	Farbe Color Couleur Colore Color	Symbollage Mounting Pos. demon. Montaggio Montaje				Bestell-Nr. Order No. No. de cde N. di ordine Referencia									
			normal	90° ↷	180° ↷	270° ↷					normal	90° ↷	180° ↷	270° ↷										
	Kühlung Cooling	gr	X																					
	Lüftungsmotor Ventilator motor	gr	X																					
	Motorkühlung Engine cooling	gr	X																					
	Sitzheizung Seat heating	gr	X																					
	Ventilator (Decke) Fan (ceiling)	gr	X																					
	Zusatzheizung Additional heating	gr	X																					

Einsätze für Baureihe 533

Inserts 533
Éléments 533
Piastrine 533
Elementes 533



Symbol Symbol Symbole Simbolo Símbolo	Benennung Description Dénomination Denominazione Denominación	Farbe Color Couleur Colore Color	Symbollage Mounting Pos. demon. Montaggio Montaje				Bestell-Nr. Order No. No. de cde N. di ordine Referencia	Symbol Symbol Symbole Simbolo Símbolo	Benennung Description Dénomination Denominazione Denominación	Farbe Color Couleur Colore Color	Symbollage Mounting Pos. demon. Montaggio Montaje				Bestell-Nr. Order No. No. de cde N. di ordine Referencia										
			normal	90° ↷	180° ↷	270° ↷					normal	90° ↷	180° ↷	270° ↷											
VI. Getriebe																									
	Abgas autom. Exhaust gases automatic	gr			X																				
	Getriebe Gear	gr		X																					
	Getriebe hoch / runter Gear highly / down	gr		X																					
	Getriebezuschaltung Gear circuit	gr			X																				
	Getriebezuschaltung halten Gear circuit hold	gr				X																			
	Motorspannung Engine voltage	gr		X																					
	Spannung / Batterie voltage / battery	gr		X																					
	Spannung / vorglühen Voltage / pre-heat	gr		X																					
	Stufe 4 Gradates 4	gr		X																					

Einsätze für Baureihe 533

Inserts 533
Éléments 533
Piastrine 533
Elementes 533







Symbol Symbol Symbole Simbolo Símbolo	Benennung Description Dénomination Denominazione Denominación	Farbe Color Couleur Colore Color	Symbollage Mounting Pos. demon. Montaggio Montaje				Bestell-Nr. Order No. No. de cde N. di ordine Referencia	Symbol Symbol Symbole Simbolo Símbolo	Benennung Description Dénomination Denominazione Denominación	Farbe Color Couleur Colore Color	Symbollage Mounting Pos. demon. Montaggio Montaje				Bestell-Nr. Order No. No. de cde N. di ordine Referencia								
			normal	90° ↷	180° ↷	270° ↷					normal	90° ↷	180° ↷	270° ↷									
VII. Baustellenfahrzeug																							
	Abstützung links hoch / runter Support left highly / down	gr	X																				
	Abstützung rechts hoch / runter Support right highly / down	gr	X																				
	Kippen links / rechts Tilt left / right	gr				X																	
	Mischen Mixed	gr	X																				
	Presse 1 Press 1	gr	X																				
	Presse sperren Press close	gr	X																				
	Stempel Stamp	gr	X																				
	Walze Rolls	gr				X																	

Einsätze für Baureihe 533

Inserts 533
 Éléments 533
 Piastrine 533
 Elementes 533





Symbol Symbol Symbole Símbolo Símbolo	Benennung Description Dénomination Denominazione Denominación	Farbe Color Couleur Colore Color	Symbollage Mounting Pos. demon. Montaggio Montaje				Bestell-Nr. Order No. No. de cde N. di ordine Referencia	Symbol Symbol Symbole Símbolo Símbolo	Benennung Description Dénomination Denominazione Denominación	Farbe Color Couleur Colore Color	Symbollage Mounting Pos. demon. Montaggio Montaje				Bestell-Nr. Order No. No. de cde N. di ordine Referencia
			normal	90° ↷	180° ↷	270° ↷					normal	90° ↷	180° ↷	270° ↷	
VIII. Geschwindigkeit															
 	Motorgeschwindigkeit Engine speed	gr	X				587 674								
 	Schnell / langsam Fast / slowly	gr	X				587 505								

Einsätze für Baureihe 533

Inserts 533
 Éléments 533
 Piastrine 533
 Elementes 533



Symbol Symbol Symbole Simbolo Símbolo	Benennung Description Dénomination Denominazione Denominación	Farbe Color Couleur Colore Color	Symbollage Mounting Pos. demon. Montaggio Montaje				Bestell-Nr. Order No. No. de cde N. di ordine Referencia	Symbol Symbol Symbole Simbolo Símbolo	Benennung Description Dénomination Denominazione Denominación	Farbe Color Couleur Colore Color	Symbollage Mounting Pos. demon. Montaggio Montaje				Bestell-Nr. Order No. No. de cde N. di ordine Referencia
			normal	90° ↷	180° ↷	270° ↷					normal	90° ↷	180° ↷	270° ↷	
IX. Flüssigkeit															
 	Kühlgeschwindigkeits-Regelung Cooling speed control	gr	X				587 499								

Einsätze für Baureihe 533

Inserts 533
Éléments 533
Piastrine 533
Elementes 533



Symbol Symbol Symbole Símbolo Símbolo	Benennung Description Dénomination Denominazione Denominación	Farbe Color Couleur Colore Color	Symbollage Mounting Pos. demon. Montaggio Montaje				Bestell-Nr. Order No. No. de cde N. di ordine Referencia	Symbol Symbol Symbole Símbolo Símbolo	Benennung Description Dénomination Denominazione Denominación	Farbe Color Couleur Colore Color	Symbollage Mounting Pos. demon. Montaggio Montaje				Bestell-Nr. Order No. No. de cde N. di ordine Referencia						
			normal	90° ↘	180° ↙	270° ↗					normal	90° ↘	180° ↙	270° ↗							
	Fensterheber Window lifter	gr	X						Heben gegen Anschlag Lift against stop	gr	X					588 574					588 967
	Füllen / leeren Fill / empty	gr	X						Horn Horn	bl	X					587 474					588 062
	Gepäckraumklappe Boot lid	gr	X						Horn aus Horn out	gr	X					588 330					587 490
	Geschwindigkeit autom. Speed automatic	gr	X						Horn rückwärts Horn backwards	rt	X					588 130					588 117
	Getriebe aus Gear out	gr	X						Horn rückwärts Horn backwards	gr	X					588 572					588 326
	Hauptschalter Main switch	gr	X						Hostessruf Hostess call	gr	X					588 311					587 740
	Hauptschalter Main switch	gr	X						Info Info	gr	X					588 096					588 623
	Hebel hydraulisch sperren Hydraulic lever locked	gr	X						Kamera Camera	gr	X					588 222					588 318
		rt	X							gr	X						588 070				
	Heben gegen Anschlag Lift against stop	gr	X						Kipper Ladeflächenrückstellung Tipper to horizontal	gr	X					588 038					588 157

Einsätze für Baureihe 533

Inserts 533
Éléments 533
Piastrine 533
Elementes 533



Symbol Symbol Symbole Símbolo Símbolo	Benennung Description Dénomination Denominazione Denominación	Farbe Color Couleur Colore Color	Symbollage Mounting Pos. demon. Montaggio Montaje				Bestell-Nr. Order No. No. de cde N. di ordine Referencia	Symbol Symbol Symbole Símbolo Símbolo	Benennung Description Dénomination Denominazione Denominación	Farbe Color Couleur Colore Color	Symbollage Mounting Pos. demon. Montaggio Montaje				Bestell-Nr. Order No. No. de cde N. di ordine Referencia						
			normal	90° ↷	180° ↶	270° ↷					normal	90° ↷	180° ↶	270° ↷							
	Kraftstoff Fuel	gr	X						Motorflüssigkeitsstand Engine liquid indicator	gr	X					588 624					588 008
	langsam, schnell slow, fast	gr	X						Parkbremse Parking brake	gr	X					588 046					588 578
	Links / rechts Left / right	gr	X						Parkbremse Parking brake	rt	X										588 102
	Mode Mode	gr	X						Parkbremse Parking brake	rt	X					587 471					588 077
	Motor Engine	gr	X						Presse aus Press out	gr	X					588 036					588 122
	Motor Stop Engine stop	gr	X						Radio / Musik Radio / music	gr	X					587 890					587 748
	Motor Stufe drei Engine grade 3	gr	X						Retarder Retarder	gr	X					588 325					588 571
	Motorbremse Engine brake	gr	X						Retarder, Motorbremse Retarder, Retarder	gr	X					587 898					588 297
	Motorbremse Engine brake	gr	X						Retarder, Abgasbremse Retarder, Exhaust brake	gr	X					588 313					588 193
	Motorbremse Engine brake	gr	X						Retarder Retarder	gr	X					588 304					588 306

Einsätze für Baureihe 533

Inserts 533
Éléments 533
Piastrine 533
Elementes 533











Symbol Symbol Symbole Simbolo Símbolo	Benennung Description Dénomination Denominazione Denominación	Farbe Color Couleur Colore Color	Symbollage Mounting Pos. demon. Montaggio Montaje				Bestell-Nr. Order No. No. de cde N. di ordine Referencia	Symbol Symbol Symbole Simbolo Símbolo	Benennung Description Dénomination Denominazione Denominación	Farbe Color Couleur Colore Color	Symbollage Mounting Pos. demon. Montaggio Montaje				Bestell-Nr. Order No. No. de cde N. di ordine Referencia										
			normal	90° ↘	180° ↙	270° ↗					normal	90° ↘	180° ↙	270° ↗											
	Retarder aus Retarder out	gr	X						Schaufel waagrecht Bucket loader horizontally	gr	X					588 328					588 131				
R	Rückwärtsgang Reset	gr	X						Schaufelfederung Bucket loader suspension	bl	X					588 110					588 075				
										gr	X													588 220	
	Schälmesser Peeling knife	gr	X						Schmierung autom. Lubricate automatic	gr	X					588 315						587 985			
	Schaufel entsperren Bucket loader unlocked	rt	X						Schmierung autom. Lubricate automatic	bl	X					588 115							588 682		
										gr	X														588 713
	Schaufel entsperren Bucket loader unlocked	gr	X						Schulbus School bus	gr	X					588 218							588 343		
		rt	X																						
	Schaufel entsperren Bucket loader unlocked	gr	X						Schwimmerstellung Float position	gr	X					588 230								588 126	
		rt	X															588 068							
	Schaufel LSM Bucket loader LSM	gr	X						Seite verschieben Side shift	gr	X					588 124									588 226
										rt	X													588 069	
	Schaufel sperren Bucket loader locked	rt	X						Spannung Voltage	gr	X					588 034									587 680
	Schaufel sperren Bucket loader locked	rt	X						Sprühwasser Spray water	gr	X					587 917									587 662

Einsätze für Baureihe 533

Inserts 533
Éléments 533
Piastrine 533
Elementes 533



Symbol Symbol Symbole Simbolo Símbolo	Benennung Description Dénomination Denominazione Denominación	Farbe Color Couleur Colore Color	Symbollage Mounting Pos. demon. Montaggio Montaje				Bestell-Nr. Order No. No. de cde N. di ordine Referencia	Symbol Symbol Symbole Simbolo Símbolo	Benennung Description Dénomination Denominazione Denominación	Farbe Color Couleur Colore Color	Symbollage Mounting Pos. demon. Montaggio Montaje				Bestell-Nr. Order No. No. de cde N. di ordine Referencia		
			normal	90° ↘	180° ↔	270° ↙					normal	90° ↘	180° ↔	270° ↙			
	Sprühwasser Walzenbesen Spray water roller broom	gr	X						Tellerbesen Circular broom	gr	X					587 979	587 694
	Sprühwasserabstand regulieren Spray water adjust	gr	X						Tellerbesen kippen links Circular broom tilt left	gr	X					587 684	587 688
	Stabilisierungsmitte Stabilization center	gr	X						Tellerbesen kippen rechts Circular broom tilt right	gr	X					587 742	587 686
	Stellung auf, Stellung ab Position open	gr	X						Tellerbesen links runter Circular broom left down	gr	X					588 189	587 678
	Steuerpumpe Control pump	rt	X						Tellerbesen rechts runter Circular broom right down	gr	X					588 044	587 676
			X														587 481
	Steuerpumpe Control pump	rt	X					TEST	Test Test	gr	X					588 043	588 213
	Steuerpumpe Control pump	rt	X						Ton aus Sound out	gr	X					587 965	588 016
	Störung der Bremsanlage Brake system trouble	gr	X						Türöffner Door opener	gr	X					588 321	588 342
										rt	X					588 341	
123	Stufenschaltung Stage switching	gr	X						Türöffner Door opener	gr	X					588 299	588 314

Wald Antriebe GmbH
Hanns-Hoerbiger-Straße 1
29664 Walsrode
Germany

Tel: +49 (0) 51 61 - 48 6 32 0
Fax: +49 (0) 51 61 - 48 6 32 33
E-Mail: info@waldantriebe.de

www.waldantriebe.de

Wald Antriebe



A *Nidec* Group Company

Nidec
Motors & Actuators

-All for dreams

Valeo